

Haier

Induction Cooktop

Instruction Manual / Installation Manual

MODEL

HCI302TB3

HCI604TB3

HCI604TG3

HCI604TPB3

HCI604FTB3

HCI905FTB3

NZ AU

Safety and Warnings

Your safety is important to us. Please read this information before using your cooktop.

INSTALLATION



WARNING: Electrical Shock Hazard

- Disconnect the appliance from the mains electricity supply before carrying out any work or maintenance on it.
- Connection to a good earth wiring system is essential and mandatory.
- Alterations to the domestic wiring system must only be made by a qualified electrician.
- Failure to follow this advice may result in electrical shock or death.



WARNING: Cut Hazard

- Take care - panel edges are sharp.
- Failure to use caution could result in injury or cuts.

Important Safety Instructions

- Read these instructions carefully before installing or using this appliance.
- No combustible material or products should be placed on this appliance at any time.
- Please make this information available to the person responsible for installing the appliance as it could reduce your installation costs.
- In order to avoid a hazard, this appliance must be installed according to these instructions for installation.
- This appliance is to be properly installed and earthed only by a suitably qualified person.
- This appliance should be connected to a circuit which incorporates an isolating switch providing full disconnection from the power supply.
- Failure to install the appliance correctly could invalidate any warranty or liability claims.

OPERATION AND MAINTENANCE

WARNING:Electrical Shock Hazard

- Do not cook on a broken or cracked cooktop. If the cooktop surface should break or crack, switch the appliance off immediately at the mains power supply (wall switch) and contact a qualified technician.
- Switch the cooktop off at the wall before cleaning or maintenance.
- Failure to follow this advice may result in electrical shock or death.

WARNING:Health Hazard

- This appliance complies with electromagnetic safety standards.
- However, persons with cardiac pacemakers or other electrical implants (such as insulin pumps) must consult with their doctor or implant manufacturer before using this appliance to make sure that their implants will not be affected by the electromagnetic field.
- Failure to follow this advice may result in death.

WARNING:Hot Surface Hazard

- During use, accessible parts of this appliance will become hot enough to cause burns.
- Do not let your body, clothing or any item other than suitable cookware contact the ceramic glass until the surface is cool.
- Metallic objects such as knives, forks, spoons and lids should not be placed on the hob surface since they can get hot
- Keep children away.
- Handles of saucepans may be hot to touch. Check saucepan handles do not overhang other cooking zones that are on. Keep handles out of reach of children.
- Failure to follow this advice could result in burns and scalds.

WARNING:Cut Hazard

- The razor-sharp blade of a cooktop scraper is exposed when the safety cover is retracted. Use with extreme care and always store safely and out of reach of children.
- Failure to use caution could result in injury or cuts.

Important Safety Instructions

- Never leave the appliance unattended when in use. Boilover causes smoking and greasy spillovers that may ignite.
- Never use your appliance as a work or storage surface.
- Never leave any objects or utensils on the appliance.
- Never use your appliance for warming or heating the room.
- After use, always turn off the cooking zones and the cooktop as described in this manual (i.e. by using the touch controls).
- Do not allow children to play with the appliance or sit, stand, or climb on it.
- Do not store items of interest to children in cabinets above the appliance. Children climbing on the cooktop could be seriously injured.
- Do not leave children alone or unattended in the area where the appliance is in use.
- Children or persons with a disability or lack of experience and knowledge, which limits their ability to use the appliance should have a responsible and competent person to instruct them in its use. The instructor should be satisfied that they can use the appliance without danger to themselves or their surroundings.
- Do not repair or replace any part of the appliance unless specifically recommended in the manual. All other servicing should be done by a qualified technician.
- Do not use a steam cleaner to clean your cooktop.
- Do not place or drop heavy objects on your cooktop.
- Do not stand on your cooktop.
- Do not use pans with jagged edges or drag pans across the Ceramic glass surface as this can scratch the glass.
- Do not use scourers or any other harsh abrasive cleaning agents to clean your cooktop, as these can scratch the Ceramic glass.
- If the supply cord is damaged, it must be replaced by the manufacturer, its service agent or similarly qualified persons in order to avoid a hazard.
- This appliance is not intended for use by persons (including children) with reduced physical, sensory or mental capabilities, or lack of experience and knowledge, unless they have been given supervision or instruction concerning use of the appliance by a person responsible for their safety.

- Children should be supervised to ensure that they do not play with the appliance.
- Cleaning and user maintenance shall not be made by children without supervision.
- The appliance is not intended to be operated by means of an external timer or separate remote-control system.

CAUTION: The cooking process has to be supervised. A short term cooking process has to be supervised continuously.

Product Dimensions

HCI302TB3

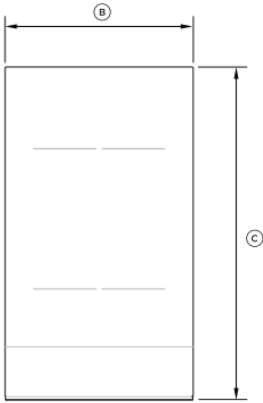

PLAN

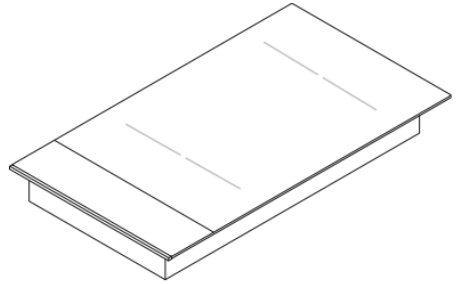

ISOMETRIC

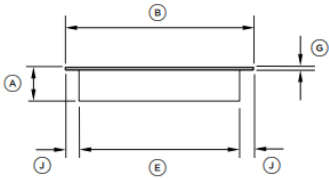

FRONT

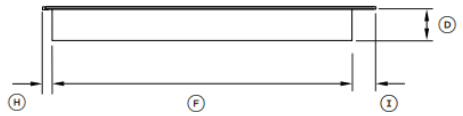

PROFILE

HCI302TB3

PRODUCT DIMENSIONS	HCI302TB3
	mm
A Overall height of cooktop	60
B Overall width of cooktop	288
C Overall depth of cooktop	520
D Height of chassis	56
E Width of chassis	261
F Depth of chassis	493
G Height of cooktop glass	4
H Depth of front overhang of cooktop glass	13.5
I Depth of rear overhang of cooktop glass	13.5
J Depth of side overhang of cooktop glass	13.5

HCI604TB3/HCI604TG3/HCI604TPB3

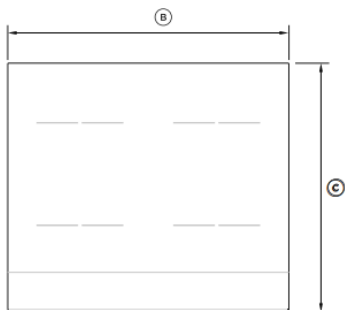

PLAN

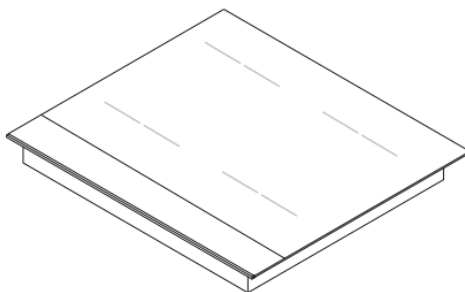

ISOMETRIC

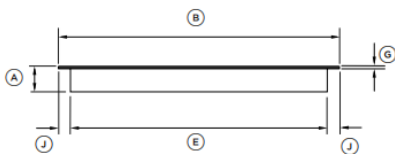

FRONT

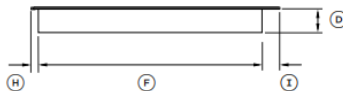

PROFILE

HCI604TB3/HCI604TG3/HCI604TPB3

PRODUCT DIMENSIONS	HCI604TB3/HCI604TG3/HCI604TPB3
	mm
A Overall height of cooktop	60
B Overall width of cooktop	590
C Overall depth of cooktop	520
D Height of chassis	56
E Width of chassis	557
F Depth of chassis	487
G Height of cooktop glass	4
H Depth of front overhang of cooktop glass	16.5
I Depth of rear overhang of cooktop glass	16.5
J Depth of side overhang of cooktop glass	16.5

HCI604FTB3

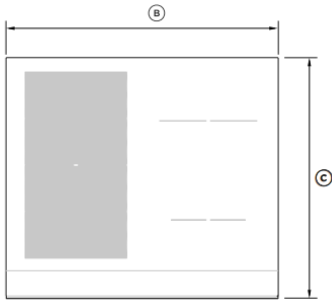

PLAN

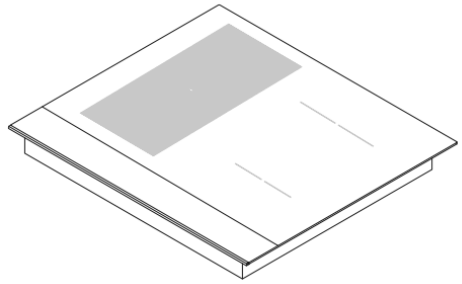

ISOMETRIC

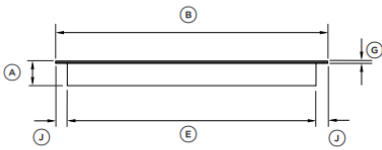

FRONT

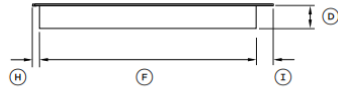

PROFILE

HCI604FTB3

PRODUCT DIMENSIONS	HCI604FTB3
	mm
A Overall height of cooktop	60
B Overall width of cooktop	590
C Overall depth of cooktop	520
D Height of chassis	56
E Width of chassis	557
F Depth of chassis	487
G Height of cooktop glass	4
H Depth of front overhang of cooktop glass	16.5
I Depth of rear overhang of cooktop glass	16.5
J Depth of side overhang of cooktop glass	16.5

HCI905FTB3

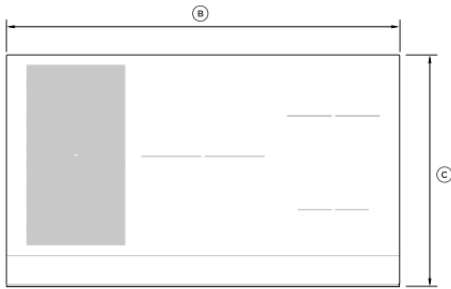

PLAN

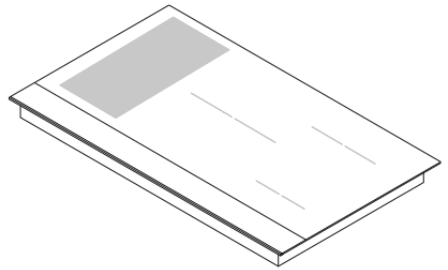

ISOMETRIC



FRONT

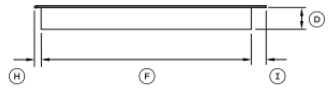

PROFILE

HCI905FTB3

PRODUCT DIMENSIONS	HCI905FTB3
	mm
A Overall height of cooktop	60
B Overall width of cooktop	900
C Overall depth of cooktop	520
D Height of chassis	56
E Width of chassis	861
F Depth of chassis	481
G Height of cooktop glass	4
H Depth of front overhang of cooktop glass	19.5
I Depth of rear overhang of cooktop glass	19.5
J Depth of side overhang of cooktop glass	19.5

Installation

Cutout Dimensions

Cut out the benchtop according to the sizes shown in the drawing.

For the purpose of installation and use, a minimum of 5 cm clearance shall be maintained around the hole.

Be sure the thickness of the work surface is at least 18mm. As shown below:

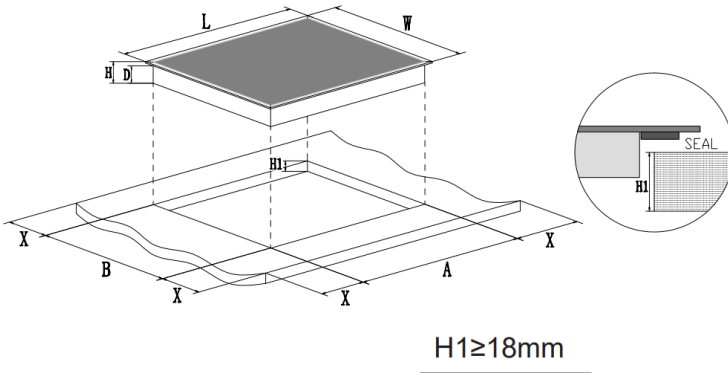

Model	L (mm)	W (mm)	H (mm)	D (mm)	A (mm)	B (mm)	X (mm)
HCI302TB3	288	520	60	56	268 ⁺⁵	500 ⁺⁵	47min
HCI604TB3	590	520	60	56	562 ^(-2 +3)	492 ^(-2 +3)	50 min
HCI604TG3	590	520	60	56	562 ^(-2 +3)	492 ^(-2 +3)	50 min
HCI604TPB3	590	520	60	56	562 ^(-2 +3)	492 ^(-2 +3)	50 min
HCI604FTB3	590	520	60	56	562 ^(-2 +3)	492 ^(-2 +3)	50 min
HCI905FTB3	900	520	60	56	870 ⁺⁵	490 ⁺⁵	50 min

Note: 60cm models will fit into existing benchtop cut outs which may be A = 560mm & B = 490mm per tolerance above.

Clearance Dimensions

Under all circumstances, make sure the cooktop is well ventilated and the air inlet and outlet are not blocked. Ensure the cooktop is in a good work state. As shown below

 Note: The distance between the hotplate and the range hood above the cooking surface should be at least 600mm(A).

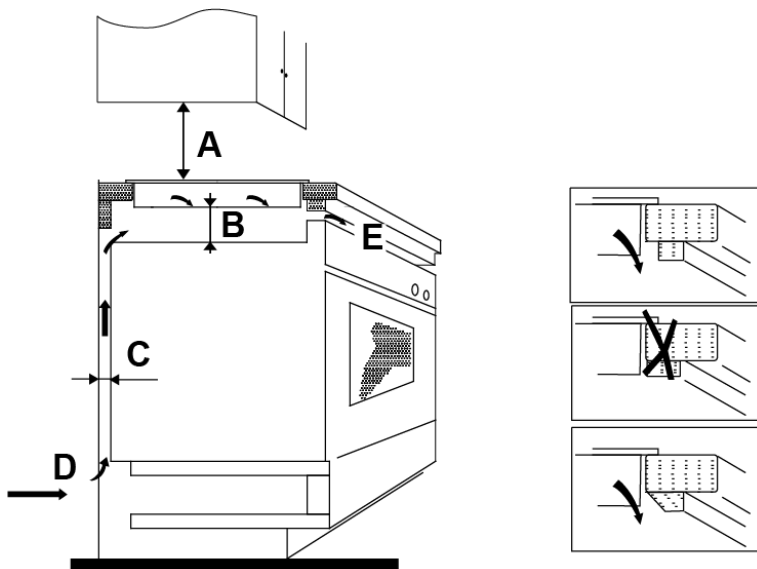

A(mm)	B(mm)	C(mm)	D	E(mm)
600 min	50 min	20 min	Air intake	Air exit 5 min

Before you install the cooktop

- The cooktop must be installed by qualified personnel or technicians.
- The benchtop is square and level, and no structural members interfere with space requirements
- The work surface is made of a heat-resistant material
- The cooktop will not be installed directly above a dishwasher, fridge, freezer, washing machine or clothes dryer, as the humidity may damage the cooktop.
- If the cooktop is installed above an oven, the oven has a built-in cooling fan
- The installation will comply with all clearance requirements and applicable standards and regulations
- A suitable isolating switch providing full disconnection from the mains power supply is incorporated in the permanent wiring, mounted and positioned to comply with the local wiring rules and regulations.

The isolating switch must be of an approved type and provide a 3 mm air gap contact separation in all poles (or in all active [phase] conductors if the local wiring rules allow for this variation of the requirements)

- You consult local building authorities and by-laws if in doubt regarding installation
- You use heat-resistant and easy-to-clean finishes (such as ceramic tiles) for the wall surfaces surrounding the hob.
- To avoid any damage, the foam seal and adhesive must be resistant to heat.

Fastening the cooktop to the bench

1. Place the cooktop on a soft and stable surface, you can use the packaging.
2. Mount the supplied brackets (B) and tighten the screws (A) onto the cooktop, as shown in below image.
3. Before installing the cooktop into the cutout, follow the steps on the next page to connect the cooktop to the mains power supply.
4. After connecting the cooktop to mains power, flip the cooktop and place it into the cutout.

CAUTION: While pressing the unit into the cutout, please pay attention to use the top surface of glass rather than the edges to avoid your fingers getting trapped in between the glass and the benchtop.

Notes:

1. **Foam seal** is already applied on the perimeter of glass bottom surface, it's not part of the packaging, please **do not remove**.
2. Minimum benchtop thickness required is 18 mm for the retaining bracket to function properly.

A	B	C	D
Screw	Retaining bracket	Screw hole	Chassis

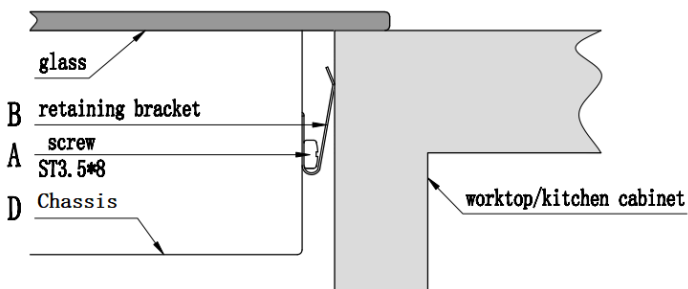
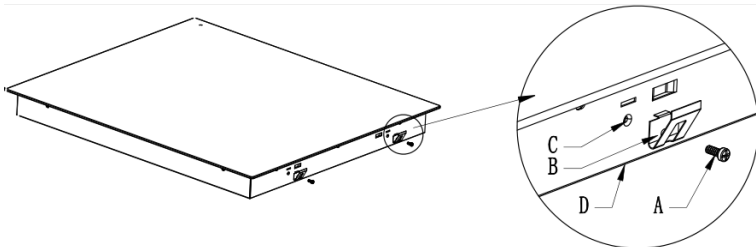

Connecting the cooktop to the mains power supply

IMPORTANT!

- **This cooktop must be connected to the mains power supply only by a suitably qualified person.**
- **This cooktop must be earthed.**
- Before connecting the cooktop to the mains power supply, check that:
 - The domestic wiring system is suitable for the power drawn by the cooktop
 - The voltage corresponds to the value given on the rating plate
 - The power supply cable sections can withstand the load specified on the rating plate.
- To connect the cooktop to the mains power supply, do not use adapters, reducers, or branching devices, as they can cause overheating and fire.
- The power supply cable must not be kinked and should not be touching the underside of the cooktop which could get hot during operation.
- If the cable is damaged or needs replacing, this should be done by an after-sales technician using the proper tools, so as to avoid any accidents.
- If the appliance is being connected directly to the mains supply, an omnipolar circuit breaker must be installed with a minimum gap of 3mm between the contacts.
- The installer must ensure that the correct electrical connection has been made and that it complies with safety regulations.
- The cable must be checked regularly and only replaced by a properly qualified person.
- The power supply should be connected in compliance with the relevant standard, or a single-pole circuit breaker. The method of connection is shown below.

IMPORTANT!

Check with an electrician whether the domestic wiring system is suitable without alterations. Any alterations must only be made by a qualified electrician.

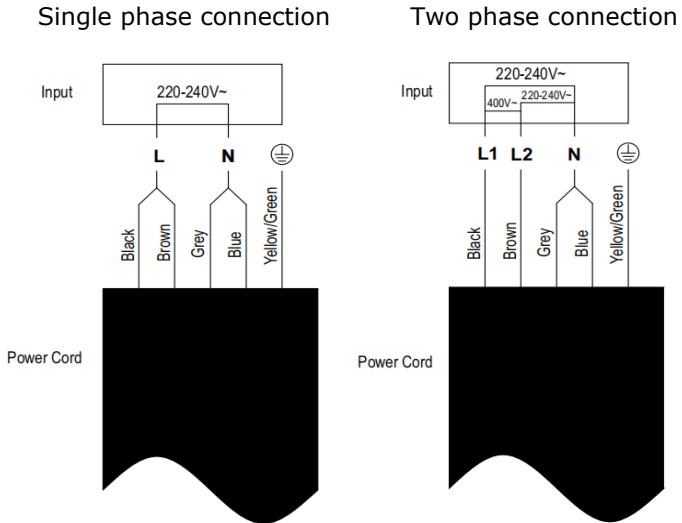

Model: HCI604TB3/HCI604TG3/HCI604TPB3/HCI604FTB3/HCI905FTB3

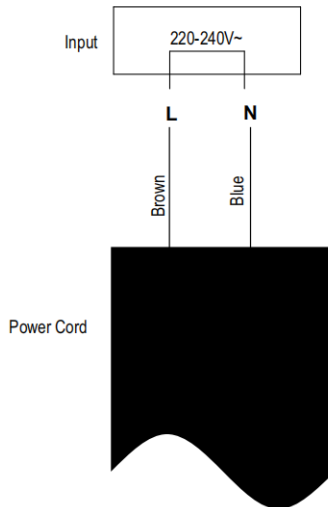

Model: HCI302TB3

When you have installed the cooktop

- The power supply cable is not accessible through cupboard doors or drawers
- There is adequate flow of fresh air from outside the cabinetry to the base of the cooktop
- If the hob is installed above a drawer or cupboard space, a thermal protection barrier is installed below the base of the hob
- The isolating switch is easily accessible by the customer

Product Overview

Top View HCI302TB3

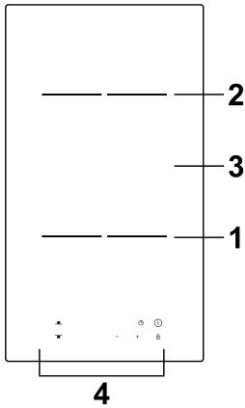

- 1. 2000 W zone
- 2. 1500 W zone
- 3. Glass plate
- 4. Control panel / Displays

Control Panel

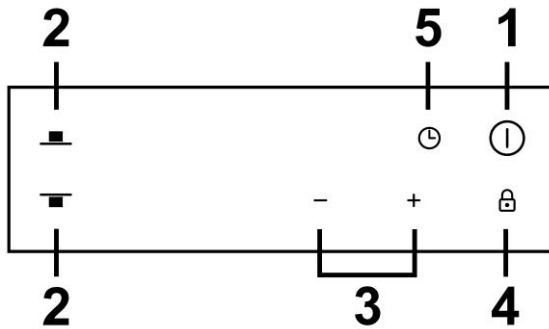

- 1. ON/OFF control
- 2. Heating zone selection controls
- 3. Power/Timer setting controls
- 4. Keylock control
- 5. Timer control

Top View HCI604TB3/HCI604TG3/HCI604TPB3

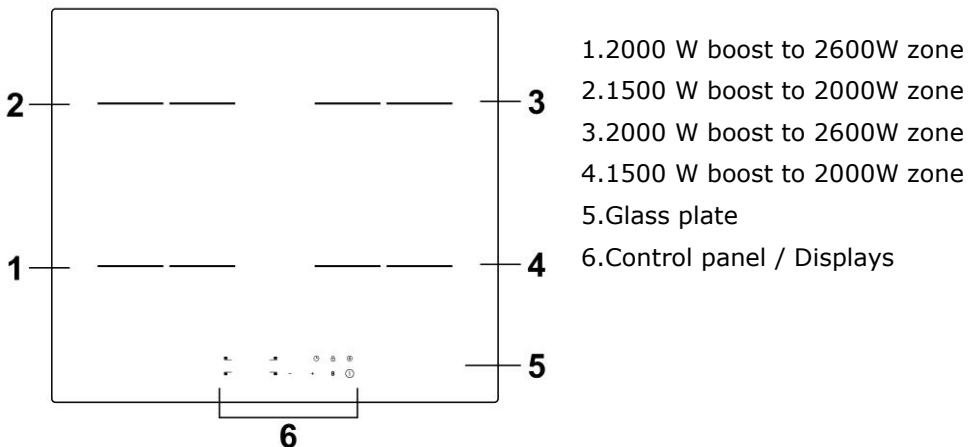

Control Panel

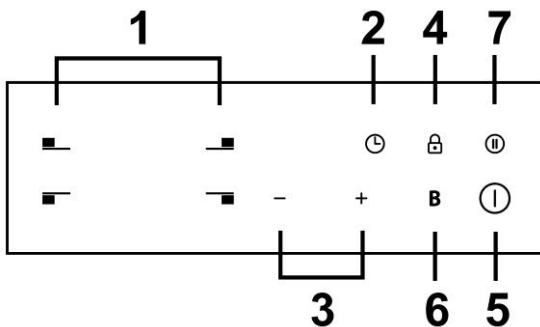

1. Heating zone selection controls
2. Timer control
3. Power/Timer setting controls
4. Keylock control
5. ON/OFF control
6. Boost function control
7. Pause function control

Top View HCI604FTB3

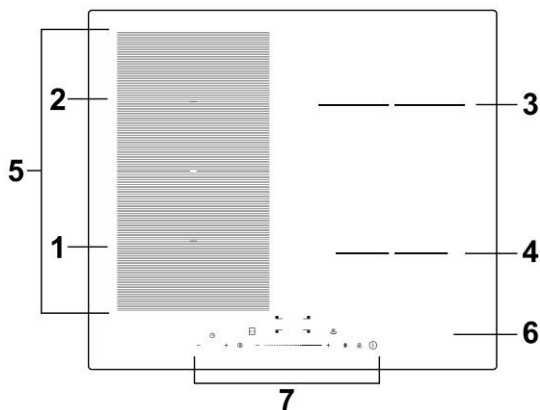

- 1.2000 W boost to 2600W zone
- 2.1500 W boost to 2000W zone
- 3.2000 W boost to 2600W zone
- 4.1500 W boost to 1800W zone
- 5.Flex zone
- 6.Glass plate
- 7.Control panel / Displays

Control Panel

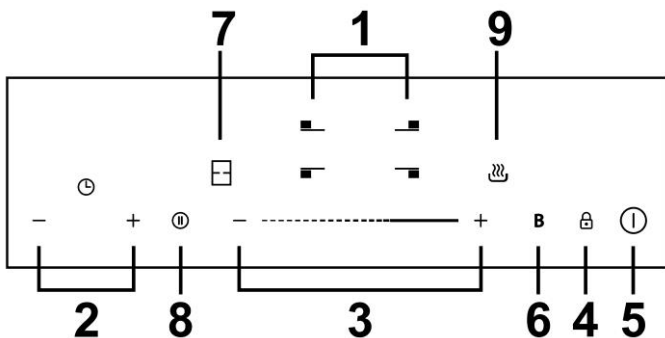

1. Heating zone selection controls
2. Timer control
3. Power setting controls
4. Keylock control
5. ON/OFF control
6. Boost function control
7. Flex zone and grill function control
8. Pause function control
9. Auto warm function

Top View HCI905FTB3

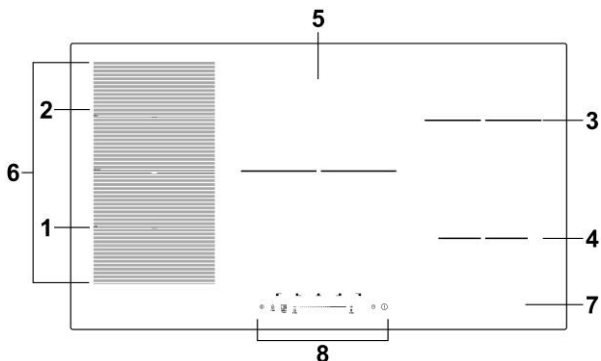

1. 2000 W boost to 2600W zone
2. 1500 W boost to 2000W zone
3. 2000 W boost to 2600W zone
4. 1500 W boost to 1800W zone
5. 2300W boost to 3000W zone
6. Flex zone
7. Glass plate
8. Control panel / Displays

Control Panel

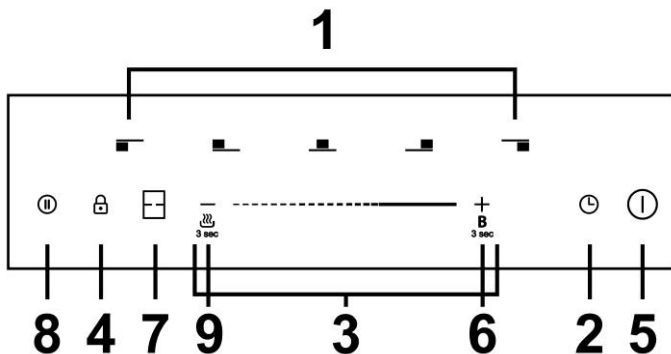

1. Heating zone selection controls
2. Timer control
3. Power setting controls
4. Keylock control
5. ON/OFF control
6. Boost function control
7. Flex zone and grill function control
8. Pause function control
9. Auto warm

A Word on Induction Cooking

Induction cooking is a safe, advanced, efficient, and economical cooking technology. It works by electromagnetic vibrations generating heat directly in the pan, rather than indirectly through heating the glass surface. The glass becomes hot only because the pan eventually warms it up.

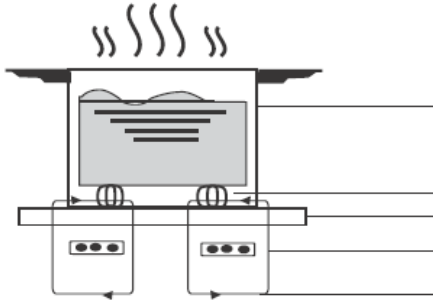

iron pot

magnetic circuit
ceramic glass plate
induction coil
induced currents

Before Using Your New Induction Cooktop

- Read this guide, taking special note of the 'Safety Warnings' section.
- Remove any protective film that may still be on your cooktop.

Using the Touch Controls

- The controls respond to touch, so you don't need to apply any pressure.
- Use the ball of your finger, not its tip.
- You will hear a beep each time a touch is registered.
- Make sure the controls are always clean, dry, and that there is no object (e.g. a utensil or a cloth) covering them. Even a thin film of water may make the controls difficult to operate.

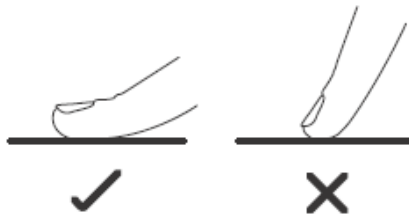

Choosing the Right Cookware



- Only use cookware with a base suitable for induction cooking. Look for the induction symbol on the packaging or on the bottom of the pan.
- You can check whether your cookware is suitable by carrying out a magnet test. Move a magnet towards the base of the pan. If it is attracted, the pan is suitable for induction.
- If you do not have a magnet:
 1. Put some water in the pan you want to check.
 2. If  does not flash in the display and the water is heating, the pan is suitable.
- Cookware made from the following materials is not suitable: pure stainless steel, aluminium or copper without a magnetic base, glass, wood, porcelain, ceramic, and earthenware.

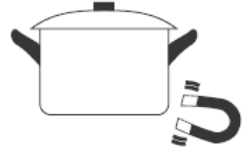

Do not use cookware with jagged edges or a curved base.



Make sure that the base of your pan is smooth, sits flat against the glass, and is the same size as the cooking zone. Use pans whose diameter is as large as the graphic of the zone selected. When using a pot with a slightly wider base, energy will be used at its maximum efficiency. If you use a smaller pot efficiency could be less than expected. Always centre your pan on the cooking zone.

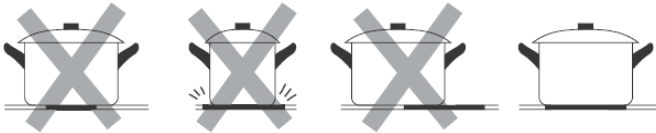

Always lift pans off the Induction hob – do not slide, or they may scratch the glass.

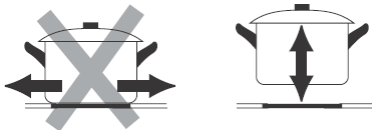

Pan dimensions

The cooking zones, automatically adapt to the diameter of the pan up to limit. However the bottom of the pan must have a minimum diameter according to the correspond cooking zone. To obtain the best efficiency of your hob, please place the pan in the centre of the cooking zone.

The base diameter of induction cookware.

HCI302TB3	
Cooking zone	Minimum (mm)
1	120
2	120

HCI604TB3, HCI604TG3, HCI604TPB3	
Cooking zone	Minimum (mm)
1	120
2	120
3	120
4	120

HCI604FTB3	
Cooking zone	Minimum (mm)
1	120
2	120
3	140
4	100
Flex zone	240

HCI905FTB3	
Cooking zone	Minimum (mm)
1	120
2	120
3	140
4	100
5	180
Flex zone	240

The above may vary according to the quality of the pan used.

Using your Induction Cooktop

To start cooking

1. Touch the ON/OFF control.

After power on, the buzzer beeps once, all displays show “-” or “- -”, indicating that the cooktop has entered into standby mode.



2. Place a suitable pan on the cooking zone that you wish to use.
 - Make sure the bottom of the pan and the surface of the cooking zone are clean and dry.

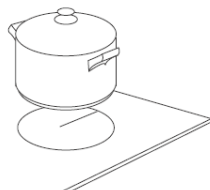

3. Touch the heating zone selection control, and the indicator next to the key will flash.



4. Set a power level by touching the “-” or “+” control or slide along the slider.



Or

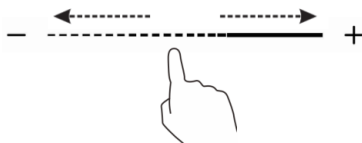

- a. If you don't select a heat zone within 1 minute, the cooktop will automatically switch off. You will need to start again at step 1.
- b. You can modify the heat setting at any time during cooking.

Note:

HCI604TPB3 is limited to 4.5kW and using two or more cooking zones at once can limit the maximum heat setting for each zone.

When you reach the maximum available heat setting for a selected zone, the setting will flash, and you will not be able to increase any more.

To increase the heat setting for a selected zone, reduce the heat setting of another cooking zone within the same Group. You will then be able to reselect the desired cooking zone and increase its heat setting.

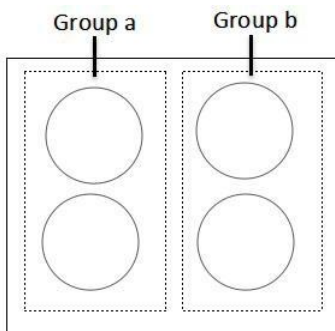

If the display flashes alternately with the heat setting

This means that:

- you have not placed a pan on the correct cooking zone or,
- the pan you're using is not suitable for induction cooking or,
- the pan is too small or not properly centred on the cooking zone.

No heating takes place unless there is a suitable pan on the cooking zone.

The display will automatically turn off after 1 minute if no suitable pan is placed on a cooking zone.

When you have finished cooking

1. Touch the heating zone selection  control that you wish to switch off.



2. Turn the cooking zone off by touching the "-" and scrolling down to "0", Make sure the power display shows "0", then shows "H".



3. For model HCI604TB3/HCI604TG3, you can also turn off the heating zone instantly by selecting the cooking zone which you want to turn off then touching “-” and “+” at the same time.

4. Turn the whole cooktop off by touching the ON/OFF control.



5. Beware of hot surfaces

‘H’ will show which cooking zone is hot to touch. It will disappear when the surface has cooled down to a safe temperature. It can also be used as an energy saving function. If you want to heat further pans, use the cooking zone that is still hot.



Using the Boost

Boost is the function where one zone is set to the highest power possible. It lasts for a maximum of 5 minutes.

This function allows you to heat up more quickly and to a higher temperature.

Using the Boost to get larger power

1. Touch the heating zone selection icon that you wish to boost, the indicator next to the key will flash.



- 2.1 For model HCI604TB3/HCI604TG3/HCI604TPB3/HCI604FTB3, press the zone selection icon and then press **B** to activate the boost function. The power display will show “P” to indicate that the zone is set to Boost mode.

- 2.2 For model HCI905FTB3, touch zone selection icon and hold **+** for 3 seconds to activate boost function. The power display will show “P^B_{3 sec}” to indicate that the zone is set to Boost mode.

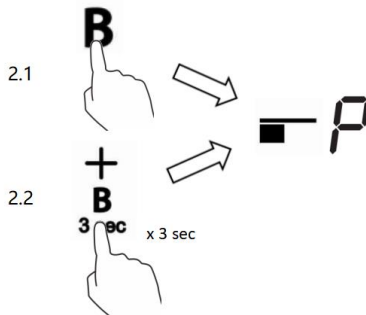

3. For HCI604TB3/HCI604TG3, the Boost power level will last for 5 minutes and then the zone will go back to the power level 9.
For the other models, the Boost power level will last for 5 minutes and then the zone will go back to the power level that was set prior boost.



4.1 For model HCI604TB3/HCI604TG3/HCI604TPB3/HCI604FTB3, touch zone selection icon and touch **B** for 1 second to quit boost function.

4.2 For model HCI905FTB3, touch zone selection icon and hold  for 3 second to quit boost function.

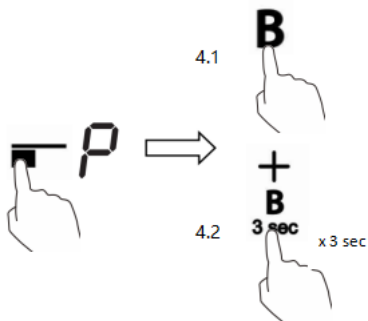

Restrictions when using

The cooktop models with four cooking zones has these zones divided into two groups. In one group, if using boost on one zone, first make sure that the other zone is set to power level 5 or below. Otherwise the boost function will be unable to activate. When the group is in flex mode, both zones can be set to boost.

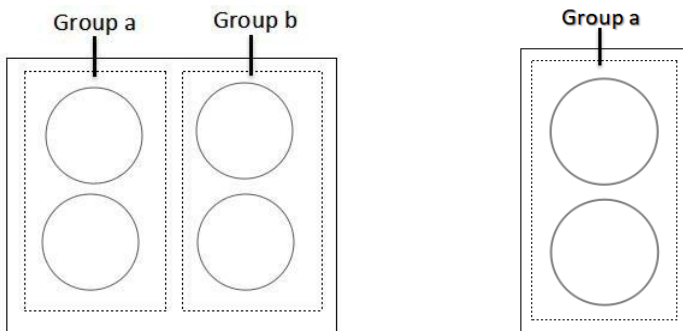

Specially for HCI604TB3/HCI604TG3, the boost function will have a different limitation in each group according to the Power Management of 2.5kW/ 3.0kW/ 4.5kW/ 6.5kW and 7.4kW that you choose.

The five zone model is also divided into two groups. In group a, if using boost on one zone, first make sure that the other zone is set to power level 5 or below. When group a is in flex mode, both zones can be set to Boost function. In group b, you can only use Boost function for one zone at a time. If you try to use the Boost function for two zones at the same time, the first zone which is using Boost function will drop out of boost function and switch to power level 5.

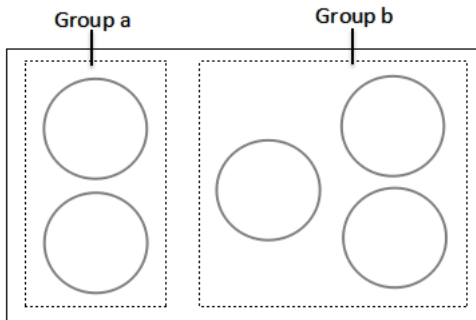

Using the Power Management

For model HCI604TB3/HCI604TG3

Using power management you can set the total power to 2.5kW/ 3.0kW/ 4.5kW/ 6.5kW and 7.4kW. The default total power setting is the maximum power level.

Setting the total power level to fit your requirement

1. Make sure the cooktop is turned off.

Note: you can only set power management when the cooktop is turned off.

2. Press and hold the "Pause" icon for 5 seconds. You can hear the buzzer beeps one time.



3. After you hear the beep, touch "+" and "-" icons at the same time and hold for 3 seconds, the timer indicator will flash with the previous total power level, e.g. '2.5'. Touch and hold "+" and "-" for 1 second again to switch to another power level, for example 3.0. When the power that you want is flashing, press and hold the "Pause" icon for 5 seconds. The buzzer will beep 10 times. It means you have changed the setting.

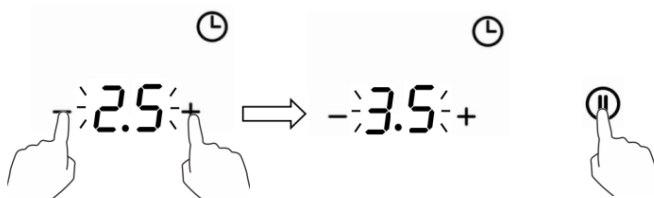

Note:

1. After step 2, you must touch the "+" and "-" **within 3 seconds** after you hear the beep. Otherwise, you will need to start again from step 2.
2. Once finish setting, wait till the end of 10 beeps. Do not touch any icon during this period. Otherwise, the setting will be invalid.

Power management Rules

If total power exceeds the limitation of 2.5kw, 3.0kw, 4.5kw, 6.5kw (depending on which level you've set), you are not able to increase power stage of any zone. If you increase it by touching '+', the cooktop will beep 3 times and indicator will show a flashing 'Pn'. Thus you need to decrease the power setting of other zones before increasing the power of the target zone.

For model HCI905FTB3

- Cooking zones are grouped according to the two phases in the cooktop (see group a & b illustration). Each phase has a maximum power loading of 3500 W. The function divides the power between cooking zones connected to the same phase.
- Group b has a function that decreases the power to the other cooking zones when the total power to group b exceeds 3500W
- Group b hasWhen using 3 cooking zones at the same time in group b, all 3 cooking zones can used up to power level 7
- When using 2 cooking zones in group b, the cooking zones can use up to power level 8 at the same time
- When only using 1 cooking zone in group b, the highest power level of the zone is Boost

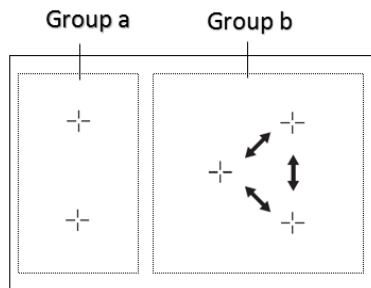

Flex Zone

- This area can be used as a single zone or as two different zones, according to cooking needs.
- The flex zone is made of two independent inductors that can be controlled separately. When working as a single zone, as cookware is moved from one zone to another within the flexible area the cooktop will keep the power level for the cookware constant. The part that is no longer covered by cookware will not heat.
- Important: Make sure to place the cookwares centered on the single cooking zone. In case of big pot, oval, rectangular and elongated pans make sure to place the pans centered on the cooking zone covering both crosses.

Examples for good and bad pot placements:

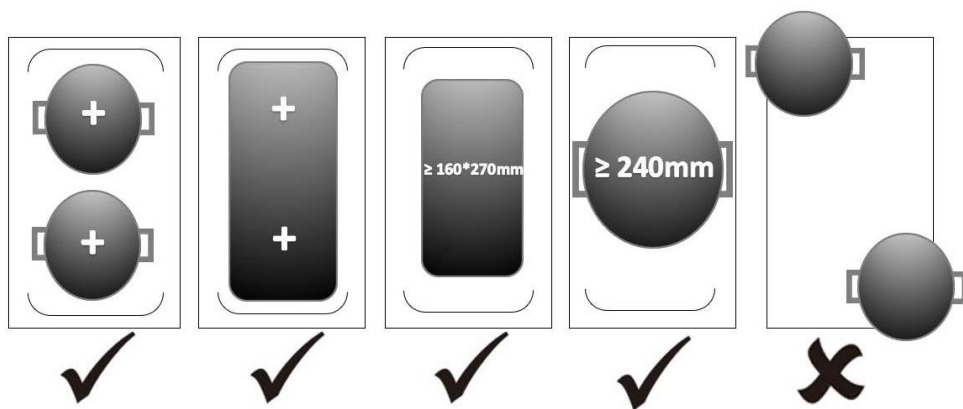

As single zone

1. To activate the flexible area as a single big zone, choose the zone which has flex function and press the flex zone icon as shown on the right image.
2. The power setting works the same as any other normal area.



As two independent zones

To use the flexible area as two different zones with different power settings, press the flex zone icon again and the zones will return into their previous settings.

Using the Flex Zone

1. Choose one zone that you want to use the flex zone function, then touch the flex zone icon. Then the zones in the flex group will show the same power level, the flex zone function is now active.

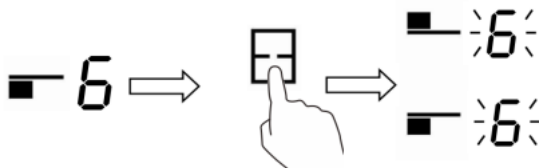

2. To turn off the flex zone, choose one of the zones in the flex group and touch the flex zone icon.

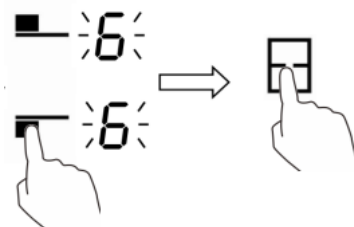

Using the Grill Function

The grill function sets the cooktop flex zone to a preset 2 hour power profile suitable for grilling.

Choose the heating zone that you wish to use Grill, hold the flex zone icon for **3 sec.**The display shows " 8 " 9" to indicate the Grill mode is on.

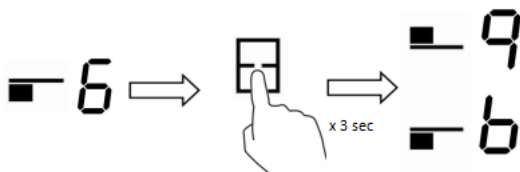

To exit the Grill function, touch one of the zone icons in the Grill group, and then hold the flex zone icon. The Grill function will be turned off.

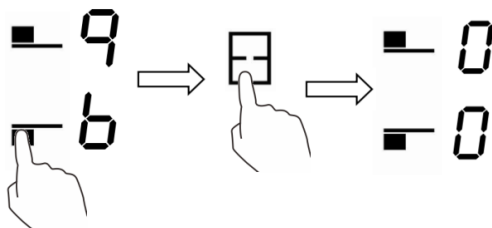

The grill function will last for 2 hours and the zones will turn off automatically. The grill function power setting with time is as shown below:

Grill Function Work Time	1 min 15 sec	45 sec	3 mins	5 mins	1h 50mins
Power Setting	8	7	6	5	4

Using the Pause Function

Pause function can be used at any time during cooking. It allows the cooking to stop instantly and then resume at the previous power settings.

1. Make sure the cook zone is powered on.

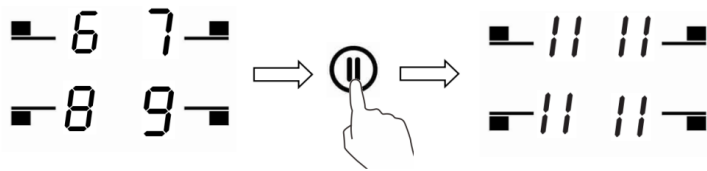

Touch the PAUSE icon, the cooking zone indicator will show "II". And then the operation of the induction cooktop will be disabled for all cooking zones, except the PAUSE, on/off and lock keys.

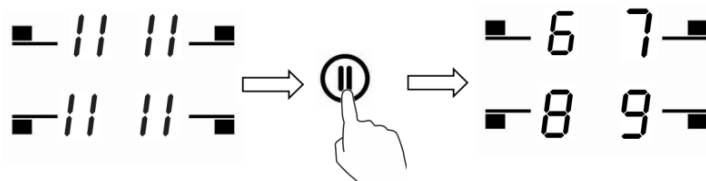

3. To cancel the pause status, touch the PAUSE icon, then the cooking zone will go back to the power level which had been set previously.



Use the Keep Warm Function

- 1.1 For model HCI604FTB3/HCI604FTG3/HCI604TPB3: Touch the desired zone select icon, then touch the keep warm icon . The zone will start keep warm mode and "A" will show on the display.
- 1.2 For model HCI905FTB3/HCI905FTG3: Touch the desired zone select icon, then hold the keep warm icon  for 3 sec. The zone will start keep warm mode and "A" will show on the display.
- 1.3 The Keep Warm function is used to maintain the temperature of the food at a lower power level. It is approximately equivalent to power level 3

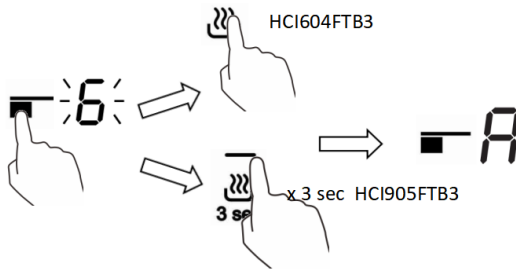

- 2.1 For model HCI604FTB3/HCI604FTG3/HCI604TPB3 to switch off the keep warm function, choose the zone that is on keep warm function, touch the keep warm icon for 1 sec the keep warm function will stop and "A" will disappear.
- 2.2 For HCI905FTB3 to switch off the keep warm function, choose the zone that is on keep warm function, touch the keep warm icon for 3 sec, the keep warm function will stop and "A" will disappear.

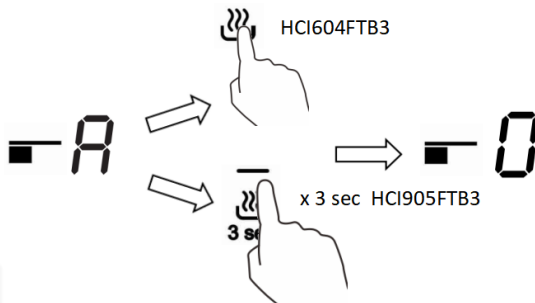

Locking the Controls

- You can lock the controls to prevent unintended use (for example children accidentally turning the cooking zones on).
- When the controls are locked, all the controls except the ON/OFF control are disabled.

To lock the controls

For model HCI302TB3, HCI604TB3, HCI604TG3, HCI604FTB3, HCI604TPB3

Touch the keylock control  , The timer indicator will show " Lo "

For model HCI905FTB3

Hold the keylock control  for 3 sec. The timer indicator will show " Lo "

To unlock the controls

1. Make sure the Induction hob is turned on.
2. Press and hold the keylock control for a 3 seconds
3. You can now start using your Induction hob.



When the hob is in the lock mode, all the controls are disable except the ON/OFF, you can always turn the induction hob off with the ON/OFF control , but you have to unlock the hob before use when next turned on.

Over-Temperature Protection

A temperature sensor inside the cooktop can monitor the internal temperature. When an excessive temperature is observed, the Induction cooktop will stop operation automatically.

Over-Spillage Protection

Over-spillage protection is a function, which will switch off the cooktop automatically within 10s if water is detected on top of the control panel, The buzzer will beep once.

Detection of Small Articles

When an unsuitable size or non-magnetic pan (e.g. aluminium), or some other small item (e.g. knife, fork, key) has been left on the hob, the hob will automatically go into standby mode in 1 minute. The fan will keep running and cooling down the induction hob for a further 1 minute, and then will be off.

Auto Shutdown Protection

Auto shut down is a protection function for your induction cooktop. It will shut down automatically if you forget to turn off your cooktop. The default working times for various power levels are shown in the below table:

Power level	1	2	3	4	5	6	7	8	9
Default working timer (hour)	8	8	8	4	4	4	2	2	2



When the pot is removed, the induction cooktop will stop heating immediately and will switch off after 2 minutes.

Using the Timer

You can use the timer in two different ways:

1. You can use it as a minute minder. In this case, the timer will not turn any cooking zone off when the set time is up.
 2. You can set it to turn one cooking zone off after the set time is up.
- You can set the timer up to 99 minutes.

Using the Timer as a Minute Minder

If you are not selecting any cooking zone

1. Make sure the cooktop is turned on.

Note: you can use the minute minder even if no cook zone is powered on.

2. Touch timer control , The minder indicator will start flashing and "30" will show in the timer display.

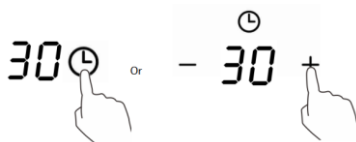

3. Set the time by touching the "-" or "+" control

Hint: Touch the "-" or "+" control once to decrease or increase by 1 minute.
Hold the "-" or "+" control to decrease or increase by 10 minutes.

4. When the time is set, it will begin to count down immediately. The display will show the remaining time and the timer indicator will flash for 5 seconds.

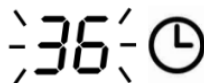

5. Buzzer will beep for 30 seconds and the timer indicator will show "--" when the set time has expired.

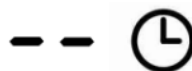

Setting the timer to turn one cooking zone off

Cooking zones set for this feature will:

1. Touch the heating zone selection control that you want to set the timer for. (e.g. zone 1#)



2. Touch timer control , The minder indicator will

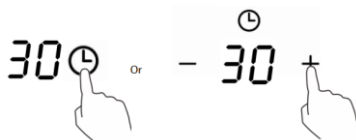

start flashing and "30" will show in the timer display.

3. Set the time by touching the "-" or "+" control.

Hint: Touch the "-" or "+" control once to decrease or increase by 1 minute.

Touch and hold the "-" or "+" control, the timer will decrease or increase by 10 minutes.

If the set time exceeds 99 minutes, the timer will automatically return to 0 minute.

4. When the time is set, it will begin to count down immediately. The display will show the remaining time and the timer indicator will flash for 5 seconds.

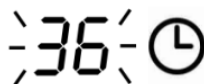

NOTE: The red dot next to power level indicator will illuminate indicating that zone is selected.

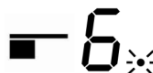

5. To cancel the timer, touch the heating zone selection control, and then touch the timer control, "00" will show in the minute display, and then "--".

6. When the cooking timer expires, the corresponding cooking zone will be automatically switch off and will show "H".



Other cooking zone will keep operating if they are turned on previously.

Setting the timer to turn more than one cooking zone off

1. If you use this function to control more than one heating zone, the timer indicator will show the shortest time.
(e.g. zone 1# set time of 3 minutes, zone 2# set time of 6 minutes, the timer indicator shows "3".)

NOTE: The flashing red dot next to power level indicator means the timer indicator is showing the time for that heating zone.

If you want to check the set time of another heating zone, touch its heating zone selection control. The timer will indicate its set time.

 6. (set to 6 minutes)

 3* (set to 3 minutes)

03 

2. When cooking timer expires, the corresponding heating zone will automatically switch off and show "H".

 H

NOTE: If you want to change the time after the timer is set, you have to start from step 1

Cooking Guidelines



Take care when frying as the oil and fat heat up very quickly, particularly if you're using PowerBoost. At extremely high temperatures oil and fat will ignite spontaneously and this presents a serious fire risk.

Cooking Tips

- When food comes to the boil, reduce the temperature setting.
- Using a lid will reduce cooking times and save energy by retaining the heat.
- Minimise the amount of liquid or fat to reduce cooking times.
- Start cooking on a high setting and reduce the setting when the food has heated through.

Simmering, cooking rice

- Simmering occurs below boiling point, at around 85°C, when bubbles are just rising occasionally to the surface of the cooking liquid. It is the key to delicious soups and tender stews because the flavours develop without overcooking the food. You should also cook egg-based and flour thickened sauces below boiling point.
- Some tasks, including cooking rice by the absorption method, may require a setting higher than the lowest setting to ensure the food is cooked properly in the time recommended.

Searing steak

To cook juicy flavoursome steaks:

1. Stand the meat at room temperature for about 20 minutes before cooking.
2. Heat up a heavy-based frying pan.
3. Brush both sides of the steak with oil. Drizzle a small amount of oil into the hot pan and then lower the meat onto the hot pan.
4. Turn the steak only once during cooking. The exact cooking time will depend on the thickness of the steak and how cooked you want it. Times may vary from about 2 – 8 minutes per side. Press the steak to gauge how cooked it is – the firmer it feels the more 'well done' it will be.
5. Leave the steak to rest on a warm plate for a few minutes to allow it to relax and become tender before serving.

For stir-frying

1. Choose an induction compatible wok or a large frying pan with a flat base.
2. Have all the ingredients and equipment ready. Stir-frying should be quick. If cooking large quantities, cook the food in several smaller batches.
3. Preheat the pan briefly and add two tablespoons of oil.

Heat Settings

The settings below are guidelines only. The exact setting will depend on several factors, including your cookware and the amount you are cooking. Experiment with the induction hob to find the settings that best suit you.

Heat setting	Suitability
1 - 2	<ul style="list-style-type: none">• delicate warming for small amounts of food• melting chocolate, butter, and foods that burn quickly• gentle simmering• slow warming
3 - 4	<ul style="list-style-type: none">• reheating• rapid simmering• cooking rice
5 - 6	<ul style="list-style-type: none">• pancakes
7 - 8	<ul style="list-style-type: none">• sautéing• cooking pasta
9	<ul style="list-style-type: none">• stir-frying• searing• bringing soup to the boil• boiling water

Care and Cleaning

What?	How?	Important!
<p>Everyday soiling on glass (fingerprints, marks, stains left by food or non-sugary spillovers on the glass)</p>	<ol style="list-style-type: none"> 1. Switch the power to the cooktop off. 2. Apply a cooktop cleaner while the glass is still warm (but not hot!) 3. Rinse and wipe dry with a clean cloth or paper towel. 4. Switch the power to the cooktop back on. 	<ul style="list-style-type: none"> • When the power to the cooktop is switched off, there will be no 'hot surface' indication but the cooking zone may still be hot! Take extreme care. • Heavy-duty scourers, some nylon scourers and harsh/abrasive cleaning agents may scratch the glass. Always read the label to check if your cleaner or scourer is suitable. • Never leave cleaning residue on the cooktop: the glass may become stained.
<p>Boilovers, melts, and hot sugary spills on the glass</p>	<p>Remove these immediately with a fish slice, palette knife or razor blade scraper suitable for Induction glass cooktops, but beware of hot cooking zone surfaces:</p> <ol style="list-style-type: none"> 1. Switch the power to the cooktop off at the wall. 2. Hold the blade or utensil at a 30° angle and scrape the soiling or spill to a cool area of the cooktop. 3. Clean the soiling or spill up with a dish cloth or paper towel. 4. Follow steps 2 to 4 for 'Everyday soiling on glass' above. 	<ul style="list-style-type: none"> • Remove stains left by melts and sugary food or spillovers as soon as possible. If left to cool on the glass, they may be difficult to remove or even permanently damage the glass surface. • Cut hazard: when the safety cover is retracted, the blade in a scraper is razor-sharp. Use with extreme care and always store safely and out of reach of children.
<p>Spillovers on the touch controls</p>	<ol style="list-style-type: none"> 1. Switch the power to the cooktop off. 2. Soak up the spill 3. Wipe the touch control area with a clean damp sponge or cloth. 4. Wipe the area completely dry with a paper towel. 5. Switch the power to the cooktop back on. 	<ul style="list-style-type: none"> • The cooktop may beep and turn itself off, and the touch controls may not function while there is liquid on them. Make sure you wipe the touch control area dry before turning the cooktop back on.

Trouble Shooting

Problem	Possible causes	What to do
The induction hob cannot be turned on.	No power.	Make sure the induction hob is connected to the power supply and that it is switched on. Check whether there is a power outage in your home or area. If you've checked everything and the problem persists, call a qualified technician.
The touch controls are unresponsive.	The controls are locked.	Unlock the controls. See section 'Using your induction cooktop' for instructions.
The touch controls are difficult to operate.	There may be a slight film of water over the controls or you may be using the tip of your finger when touching the controls.	Make sure the touch control area is dry and use the ball of your finger when touching the controls.
The glass is being scratched.	Rough-edged cookware. Unsuitable, abrasive scourer or cleaning products being used.	Use cookware with flat and smooth bases. See 'Choosing the right cookware'. See 'Care and cleaning'.
Some pans make crackling or clicking noises.	This may be caused by the construction of your cookware (layers of different metals vibrating differently).	This is normal for cookware and does not indicate a fault.
The induction hob makes a low humming noise when used on a high heat setting.	This is caused by the technology of induction cooking.	This is normal, but the noise should quieten down or disappear completely when you decrease the heat setting.
Fan noise coming from the induction hob.	A cooling fan built into your induction hob has come on to prevent the electronics from overheating. It may continue to run even after you've turned the induction hob off.	This is normal and needs no action. Do not switch the power to the induction hob off at the wall while the fan is running.
Pans do not become hot and appears  in the display.	The induction hob cannot detect the pan because it is not suitable for induction cooking. The induction hob cannot detect the pan because it is too small for the cooking zone or not properly centred on it.	Use cookware suitable for induction cooking. See section 'Choosing the right cookware'. Centre the pan and make sure that its base matches the size of the cooking zone.

The induction hob or a cooking zone has turned itself off unexpectedly, a tone sounds and an error code is displayed (typically alternating with one or two digits in the cooking timer display).	Technical fault.	Please note down the error letters and numbers, switch the power to the induction hob off at the wall, and contact a qualified technician.
---	------------------	--

Fault Codes and Troubleshooting

If an abnormality comes up, the induction cooktop will enter a protective state automatically and display corresponding fault codes:

Problem	Possible causes	What to do
F3/F4	Temperature sensor of the induction coil failure	Please contact the supplier.
F9/FA	Temperature sensor of the IGBT failure.	Please contact the supplier.
E1/E2	Abnormal supply voltage	Please check whether power supply is normal. Power on after the power supply is normal.
E3	High temperature of the induction coil temperature sensor	Please contact the supplier.
E5	High temperature of the IGBT temperature sensor	Please restart after the hob cools down.

The above covers common faults.

Please do not disassemble the unit by yourself to avoid any danger and damage to the induction hob.

Technical Specification

Cooking Hob	HCI302TB3
Cooking Zones	2 Zones
Supply Voltage	220-240V~, 50-60Hz
Installed Electric Power	3000-3800W
Product Size L×W×H(mm)	288X520X60
Cut out Dimensions AxB(mm)	268 ⁺⁵ X500 ⁺⁵

Cooking Hob	HCI604TB3,HCI604TG3,
Cooking Zones	4 Zones
Supply Voltage	220-240V~, 50-60Hz
Installed Electric Power	1.6kw: 1440-1760W or 2.0kw: 1800-2200W or 2.5kw:2250-2750W or 3.0 kw:2700-3300W or 4.5kw:4050-4950W or 6.5kw:5850-7150W or 7.4kw:6600-7400W
Product Size L×W×H(mm)	590X520X60
Cut out Dimensions AxB(mm)	562 ^(-2 +3) X492 ^(-2 +3)

Cooking Hob	HCI604TPB3
Cooking Zones	4 Zones
Supply Voltage	220-240V~, 50-60Hz
Installed Electric Power	4050W-4725W
Product Size L×W×H(mm)	590X520X60
Cut out Dimensions AxB(mm)	562 ^(-2 +3) X492 ^(-2 +3)

Cooking Hob	HCI604FTB3
Cooking Zones	4 Zones
Supply Voltage	220-240V~, 50-60Hz
Installed Electric Power	6600-7400W
Product Size L×W×H(mm)	590X520X60
Cut out Dimensions AxB(mm)	562 ^(-2 +3) X492 ^(-2 +3)

Cooking Hob	HCI905FTB3
Cooking Zones	5 Zones
Supply Voltage	220-240V~, 50-60Hz
Installed Electric Power	6800-7400W
Product Size L×W×H(mm)	900X520X60
Cut out Dimensions AxB(mm)	870 ⁺⁵ X490 ⁺⁵

Weight and Dimensions are approximate, as shown above.

Manufacturer's Warranty

Please read this warranty card carefully. Attach your purchase receipt to this warranty card and keep in a safe place. You must produce both warranty card and proof of purchase in the event of a warranty repair being required.

When you purchase any new Haier Product you automatically receive a two year Manufacturer's Warranty covering parts and labour for servicing.

The Manufacturer undertakes to:

Repair or, at its option, replace without cost to the owner either for material or labour any part of the Product, the serial number of which appears on the Product, which is found to be defective within TWO YEARS from the date of purchase.

This warranty DOES NOT cover:

- A** Service calls which are not related to any defect in the Product. The cost of a service call will be charged if the problem is not found to be a Product related fault. For example:
1. Correct the installation of the product.
 2. Provide Instruction on use of the product or change the setup of the product.
 3. Replace house fuses or correct house wiring.
 4. Correcting fault(s) caused by the user.
 5. Noise or vibration that is considered normal.
 6. Water on the floor due to incorrect loading or excessive suds.
 7. Blocked pumps, removal of foreign objects/substances from the machine, including the pump and inlet house filters.
 8. Correcting damage caused by pests, eg. rats, cockroaches etc.
 9. Correct corrosion or discolouration due to chemical attack.
 10. Power outages or surges.
- B** Defects caused by factors other than:
1. Normal domestic use or
 2. Use in accordance with the Product's User Guide.
- C** Defects to the Product caused by accident, neglect, misuse or 'Act of God'.
- D** The cost of repairs carried out by non-authorized repairers or the cost of

correcting such unauthorised repairs.

- E** Normal recommended maintenance as set out in the Product's User Guide.
- F** Repairs when the appliance has been dismantled, repaired or serviced by other than an AUTHORISED CUSTOMER SERVICE CENTRE or the selling dealer.
- G** Pick up and delivery.
- H** Transportation or travelling costs involved in the repair when the product is installed outside the AUTHORISED CUSTOMER SERVICE CENTRE'S normal service area.

This product has been designed for use in a normal domestic environment. It is not intended for commercial use. Doing so may affect product warranty. Service under this warranty must be provided by an Authorised Service Repairer (refer to the Customer Care section for contact details). Such service shall be provided during normal business hours. This warranty certificate should be shown when making any claim.

Note:

This Warranty is an extra benefit and does not affect your legal rights and applies only to product purchased in New Zealand and Australia. Please keep this Warranty Card in a safe place.

For Australian customers:

Our goods come with guarantees that cannot be excluded under the Australian Consumer Law. You are entitled to a replacement or refund for a major failure and for compensation for any other reasonably foreseeable loss or damage. You are also entitled to have the goods repaired or replaced if the goods fail to be of acceptable quality and the failure does not amount to a major failure.

Customer Care

Check the things you can do yourself.

Refer to your User Guide and check:

- 1 Your appliance is correctly installed.
- 2 You are familiar with its normal operation.
- 3 You have read the problem solving section in your User Guide.

If after checking these points you still need assistance, please refer to your nearest Haier Authorised Repairer.

In New Zealand, if you need assistance...*

Call your retailer who is trained to provide information on your appliance, or if we can be of any further help, please contact our Customer Care Centre:

Toll Free: 0800 372 273 Fax: (09) 273 0656

Email: customer.care@haier.co.nz

Postal address: P.O. Box 58732, Botany, Manukau 2163

If you need service...*

We have a network of independent Fisher & Paykel Authorised Repairers whose fully trained technicians can carry out any service necessary on your appliance. Your dealer or our Customer Care Centre can recommend a Fisher & Paykel Authorised Repairer in your area.

In Australia, if you need assistance...*

Call the Customer Care Centre and talk to one of our Customer Care Consultants.

Toll Free: 1300 729 948 Fax: (07) 3826 9298

Email: customer.care@haierlife.com.au

Postal Address: PO Box 798, Cleveland QLD 4163

If you need service...*

We have a network of qualified Authorised Repairers whose fully trained technicians can carry out any service necessary on your appliance. Our Customer Care Centre can recommend an Authorised Repairer in your area.

*If you call or write, please provide: name, address, model number, serial number, date of purchase and a description of the problem. This information is needed in

order to better respond to your request for assistance.

Product Details

Model -----Serial No. -----

Date of Purchase-----Purchaser-----

Dealer-----Suburb-----

Town-----Country-----

Thank you for choosing Haier. We are confident that you will enjoy many years of good service from your appliance.

Code: Z308720995

Edition: V20

Publication Date September 1, 2023