

The Haier logo is displayed in white text on a dark grey rectangular background in the top right corner of the page.

Haier

Induction Cooktops

INDUCTION COOKTOPS

HCI905FTB4, HCI905FTG4, HCI905TPB4, HCI905TB4,
HCI604FTB4, HCI604FTPB4, HCI604FTG4

CONTENTS

Safety and warnings	4
Cooktop overview HCI905FT4	8
Cooktop overview HCI604FT4	9
Cooktop overview HCI905TPB4, HCI905TPB4, HCI905TB4	10
Cookware	11
First Use	12
Key Lock	13
Induction cook zones	14
FlexZones	16
Features	17
Using the timer	18
Wifi/App connect	19
Hob-to-hood connect	20
Cooking guide	21
Care and cleaning	22
Troubleshooting	23
Alert codes	25
Manufacturer's warranty	26
Customer service	28

⚠ WARNING!



Electric Shock Hazard

Failure to follow this advice may result in electric shock or death.

- Do not cook on a broken or cracked cooktop. If the cooktop surface should break or crack, switch the appliance off immediately at the mains power supply (wall switch) and contact a qualified technician.
- Disconnect the appliance from the mains electricity supply before carrying out any work or maintenance on it.
- Connection to a good earth wiring system is essential and mandatory.
- Alterations to the domestic wiring system must only be made by a qualified electrician.

⚠ WARNING!



Fire Hazard

Failure to follow this advice may result in serious burns or death.

- Unattended cooking on a hob with fat or oil can be dangerous and may result in fire.
- Cover flame, eg with a lid or fire blanket, or use dry chemical or foam-type extinguisher.
- Do not store items on cooking surfaces.

⚠ WARNING!



Cut Hazard

Failure to follow this advise could result in injury and cuts.

- Take care - panel edges are sharp.
- The razor-sharp blade of a cooktop scraper is exposed when the safety cover is retracted. Use with extreme care and always store safely and out of reach of children.

⚠ WARNING!



Hot Surface Hazard

Failure to follow this advice could result in burns and scalds.

- Do not touch surface units or areas near units. Surface units maybe hot even though they are dark in colour.
- During use, accessible parts of this appliance will become hot enough to cause burns.
- Do not let your body, clothing or any item other than suitable cookware contact the ceramic glass until the surface is cool.
- Handles of saucepans may be hot to touch. Check saucepan handles do not overhang other cooking zones that are on. Keep handles out of reach of children.
- Metallic objects such as knives, forks, spoons and lids should not be placed on the hob surface as they can get hot.
- Keep children away.
- Handles of saucepans may be hot to touch. Check saucepan handles do not overhang other cooking zones that are on. Keep handles out of reach of children.

SAFETY AND WARNINGS

READ AND SAVE THIS GUIDE

General Use

- Never leave the appliance unattended when in use. Boilover causes smoking and greasy spillovers that may ignite.
- Never use your appliance as a work or storage surface.
- Never leave any objects or utensils on the appliance.
- Never use your appliance for warming or heating the room.
- After use, always turn off the cooking zones and the cooktop as described in this manual (i.e. by using the touch controls).
- Do not allow children to play with the appliance or sit, stand, or climb on it.
- Do not store items of interest to children in cabinets above the appliance. Children climbing on the cooktop could be seriously injured.
- Do not leave children alone or unattended in the area where the appliance is in use.
- Children or persons with a disability or lack of experience and knowledge, which limits their ability to use the appliance should have a responsible and competent person to instruct them in its use. The instructor should be satisfied that they can use the appliance without danger to themselves or their surroundings.
- Do not repair or replace any part of the appliance unless specifically recommended in the manual. All other servicing should be done by a qualified technician.
- Do not use a steam cleaner to clean your cooktop.
- Do not place or drop heavy objects on your cooktop.
- Do not stand on your cooktop.
- Do not use pans with jagged edges or drag pans across the Ceramic glass surface as this can scratch the glass.
- Do not use scourers or any other harsh abrasive cleaning agents to clean your cooktop, as these can scratch the Ceramic glass.
- If the power supply cord is damaged, it must be replaced by the manufacturer, its service agent or similarly qualified persons in order to avoid a hazard.
- This appliance is not intended for use by persons (including children) with reduced physical, sensory or mental capabilities, or lack of experience and knowledge, unless they have been given supervision or instruction concerning use of the appliance by a person responsible for their safety.
- Children should be supervised to ensure that they do not play with the appliance.
- Cleaning and user maintenance shall not be made by children without supervision.
- The appliance is not intended to be operated by means of an external timer or separate remote-control system.
- **CAUTION:** The cooking process has to be supervised. A short term cooking process has to be supervised continuously.
- After use, switch off the hob element using its control and do not rely on the pan detector.

Installation

- The cooktop must be installed by qualified personnel or technicians.
- Read these instructions carefully before installing or using this appliance.
- The bench top must be square and level, and no structural members should interfere with space requirements.
- The cooktop will not be installed directly above a dishwasher, fridge, freezer, washing machine or clothes dryer, as the humidity may damage the cooktop.
- If the cooktop is installed above an oven, the oven must have a built-in cooling fan.
- The installation will comply with all clearance requirements and applicable standards and regulations.
- The work surface must be made of a heat-resistant material
- No combustible material or products should be placed on this appliance at any time.

SAFETY AND WARNINGS

- Please make this information available to the person responsible for installing the appliance as it could reduce your installation costs.
- In order to avoid a hazard, this appliance must be installed according to these instructions for installation.
- This appliance should be connected to a circuit which incorporates an isolating switch providing full disconnection from the power supply.
- Failure to install the appliance correctly could invalidate any warranty or liability claims.
- Use heat-resistant and easy-to-clean finishes (such as ceramic tiles) for the wall surfaces surrounding the hob.
- Consult local building authorities and by-laws if in doubt regarding installation
- To avoid any damage, the foam seal and adhesive must be resistant to heat.

Electrical

- This cooktop must be connected to the mains power supply only by a suitably qualified person.
- This cooktop must be earthed by a suitably qualified person.
- A suitable isolating switch providing full disconnection from the mains power supply is incorporated in the permanent wiring, mounted and positioned to comply with the local wiring rules and regulations.
- The isolating switch must be of an approved type and provide a 3 mm air gap contact separation in all poles (or in all active [phase] conductors if the local wiring rules allow for this variation of the requirements).
- Before connecting the cooktop to the mains power supply, check that:
 - The domestic wiring system is suitable for the power drawn by the cooktop
 - The voltage corresponds to the value given on the rating plate
 - The power supply cable sections can withstand the load specified on the rating plate.
 - To connect the cooktop to the mains power supply, do not use adapters, reducers, or branching devices, as they can cause overheating and fire.
 - The power supply cable must not be kinked and should not be touching the underside of the cooktop which could get hot during operation.
 - If the cable is damaged or needs replacing, this should be done by an after-sales technician using the proper tools, so as to avoid any accidents.
 - If the appliance is being connected directly to the mains supply, an omni-polar circuit breaker must be installed with a minimum gap of 3mm between the contacts.
 - The installer must ensure that the correct electrical connection has been made and that it complies with safety regulations.
 - The cable must be checked regularly and if the supply cord is damaged it must be replaced by a properly qualified person.
 - The power supply should be connected in compliance with the relevant standard, or a single-pole circuit breaker. The method of connection is shown below.

Electromagnetic hazards

- This appliance complies with electromagnetic safety standards.
- However, persons with cardiac pacemakers or other electrical implants (such as insulin pumps) must consult with their doctor or implant manufacturer before using this appliance to make sure that their implants will not be affected by the electromagnetic field.
- Failure to follow this advice may result in death.

COOKTOP OVERVIEW HCI905FT4

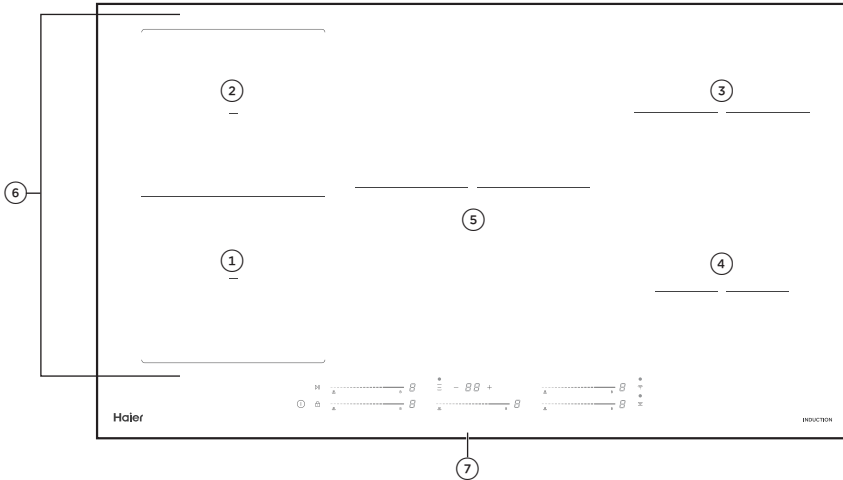

FEATURES AND ACCESSORIES

- | | | | |
|---|----------------------------------|---|--------------------------------|
| 1 | Cook zone 2000W to 2600W (boost) | 5 | MaxZone 2300W to 3500W (boost) |
| 2 | Cook zone 1500W to 2000W (boost) | 6 | FlexZone |
| 3 | Cook zone 2000W to 2600W (boost) | 7 | Control Panel |
| 4 | Cook zone 1500W to 1800W (boost) | | |

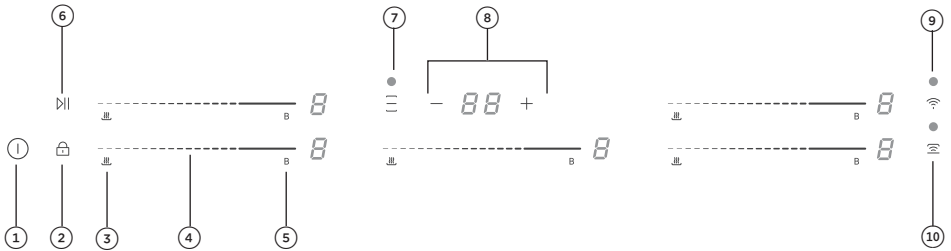

FEATURES AND ACCESSORIES

- | | | | |
|---|------------------------|----|-------------------------|
| 1 | Power on/off | 6 | Start/pause all cooking |
| 2 | Key Lock | 7 | FlexZone |
| 3 | Warm | 8 | Timer |
| 4 | Cook zone power slider | 9 | Wifi/App connection |
| 5 | Power boost | 10 | Hob-to-Hood |

COOKTOP OVERVIEW HCI604FT4

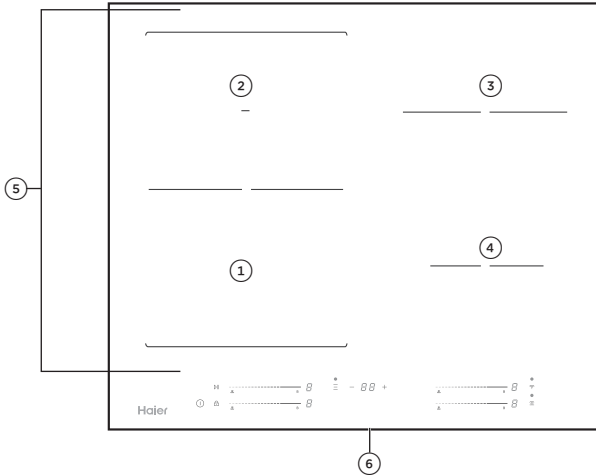

FEATURES AND ACCESSORIES

1	Cook zone 2000W to 2600W (boost)	5	FlexZone
2	Cook zone 1500W to 2000W (boost)	6	Control Panel
3	Cook zone 2000W to 2600W (boost)		
4	Cook zone 1500W to 1800W (boost)		

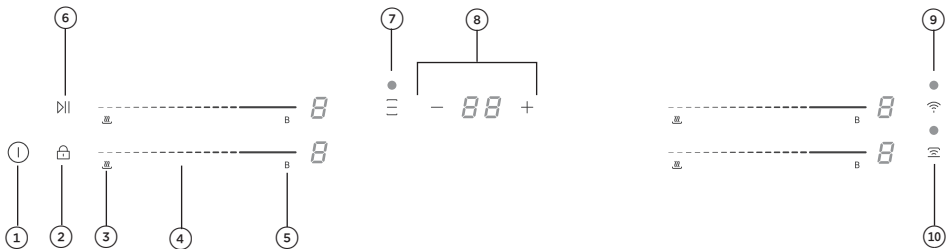

FEATURES AND ACCESSORIES

1	Power on/off	6	Start/pause all cooking
2	Key Lock	7	FlexZone
3	Warm	8	Timer
4	Cook zone power slider	9	Wifi/App connection
5	Power boost	10	Hob-to-Hood

COOKTOP OVERVIEW HCI905TPB4, HCI905TPB4, HCI905TB4

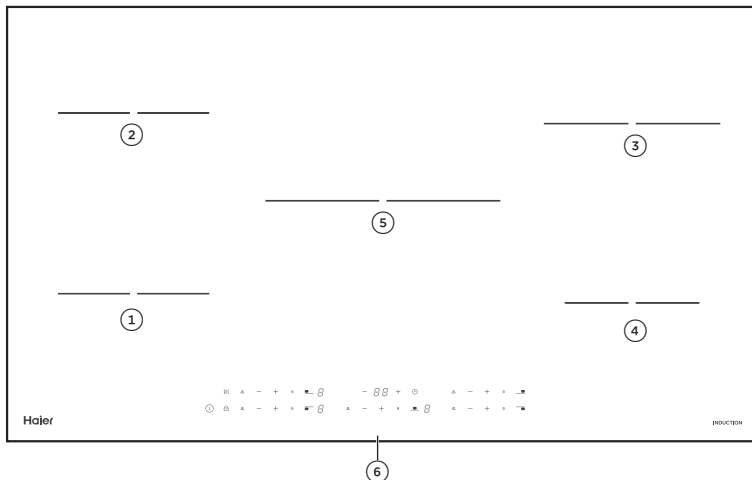

FEATURES AND ACCESSORIES

- | | | | |
|---|----------------------------------|---|---------------------------------|
| 1 | Cook zone 2000W to 2600W (boost) | 5 | Max zone 2300W to 3000W (boost) |
| 2 | Cook zone 1500W to 2000W (boost) | 6 | Control Panel |
| 3 | Cook zone 2000W to 2600W (boost) | | |
| 4 | Cook zone 1500W to 1800W (boost) | | |

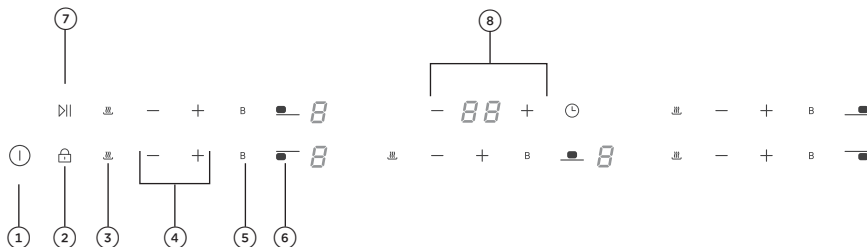

FEATURES AND ACCESSORIES

- | | | | |
|---|--------------------|---|-------------------------|
| 1 | Power on/off | 5 | Power boost |
| 2 | Key Lock | 6 | Cook zone on indicator |
| 3 | Warm | 7 | Start/pause all cooking |
| 4 | Cook zone controls | 8 | Timer |

COOKWARE

Induction cookware

The quality of your cookware can affect cooking performance. Only use induction-compatible cookware that has been specifically designed for induction cooking. Look for the induction symbol on the packaging or the bottom of the pan.

- Ensure the base of your cookware is smooth, sits flat against the glass, and is similar in size than the cooking zone.
- A small pot on a large cooking zone may not be detected. Always centre your pan on the cooking zone
- Lift pans off the cooktop. Do not slide, or they may scratch the glass.
- **Minimum pan sizes in cooking zones are 140mm diameter and in FlexZones, 240mm diameter.**

Suitable cookware material:

- stainless steel – with a magnetic base or core
- aluminium and copper – with a magnetic base or core
- cast iron
- steel
- enamelled steel.

Unsuitable cookware material:

- aluminium or copper – without a magnetic base
- glass
- wood
- porcelain
- ceramic or earthenware.

To check if cookware material is suitable for induction use, carry out a magnet test:

Move a magnet across the base of the pan. If the magnet is attracted, the pan is induction suitable. Ensure attraction is consistent across the base of the pan. If there are gaps, such as an indented manufacturer's logo, then the performance will be impaired.

If you do not have a magnet, fill the pan with some water and refer to section 'Induction cooking zones'. If  does not flash and the water is heating, pan is suitable.

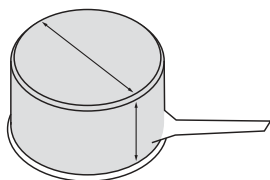

Quickest heating Performance

High content of ferromagnetic material. Heating area is consistent across the base and up the sides of pan.

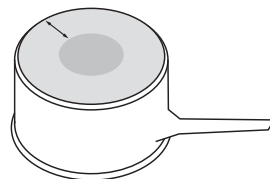

Average heating Performance

Reduced area of ferromagnetic material. Reduced zone of heating, results in poor performance and slower heating.

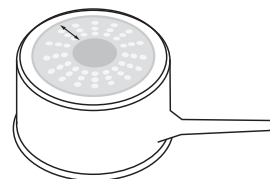

Slow heating Performance

Very limited area of ferromagnetic material. Results in very slow heating performance.

Note: This type of pot is good for very delicate tasks such as melting chocolate, as heating is very slow.

FIRST USE

Display overview

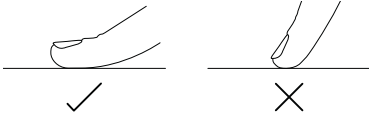

Touch display

Your cooktop is operated using an intuitive touch display. Use the control panel to navigate cooking settings.

Using the touch controls

Use the ball of your finger, not its tip. The controls respond to touch, so pressure is not needed.

ZONE DISPLAY	DESCRIPTION
	Cooktop off (not activated)
	Cooking zone on (activated but not operating)
	Power levels
	Hot surface indicator
	Pan not detected indicator
	Pan not suitable for induction
	Control Panel Spill Detection
	Warm indicator
	Lock indicator
	Pause function indicator
	Power Boost indicator

POWER MANAGEMENT FOR LOW CURRENT MODELS

Low current models are unable to maintain high power output (boost) across all cooking areas at the same time. If the power limit is reached on the selected zone, turn down one or more other zones to allow you to further increase power on the selected zone.

AUTO TURN OFF

If the cooktop is powered on but a cook zone has not been selected for 1 minute the cooktop will automatically power off.

SELECT COOKING ZONE

To use zone specific features such as PowerBoost and timer, press anywhere on the corresponding control slider. The display to the right of the slider will flash to indicate the zone has been selected. While the display is flashing, select the feature you wish to use.

KEY LOCK

Key Lock

When the cooktop is locked any zones in use will remain on and the power levels cannot be changed.



Activating Key Lock

1. Hold the keylock control for 3 seconds until  is displayed.

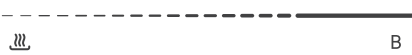



Disabling Key Lock

2. To unlock the cooktop, hold the keylock control for 3 seconds until  is dim.

INDUCTION COOK ZONES

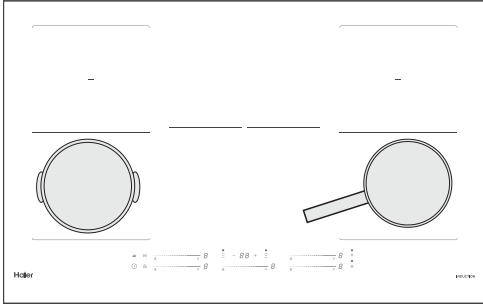

To begin cooking

Always place pans in the centre of the cooking zone. If the pan is not correctly placed  will flash.
If the pan is too small or not suitable  will flash.



1. Place a suitable pan on the desired cooking zone. Ensure the bottom of the pan and the surface of the cooking zone are clean and dry.



2. Press  to switch the cooktop on. The cooktop will beep once and all displays show  or 



3. Select a cook zone heat setting by pressing or sliding the zone power control.

 May flash for a moment as the cooktop is detecting your pan.

If you don't select a heat setting within 1 minute, the cooktop will automatically turn off.



B



HCI905T Models:

Select a cook zone heat setting by pressing + or -

 May flash for a moment as the cooktop is detecting your pan.

If you don't select a heat setting within 1 minute, the cooktop will automatically turn off.

INDUCTION COOK ZONES

To pause cooking



1. Hold start/pause for 3 seconds to pause all cooking functions, || will illuminate in all cooking zones.

To re-start, hold || for 3 seconds.

To stop cooking



2. To turn the cooking zone off, press the left end of the power control until the display shows



B



HCI905T Models:

To turn the cooking zone off, hold — for 3 seconds until the display shows



3. To turn the product off: Tap the power control.

FLEXZONES

The FlexZone function allows you to use two zones together for a larger cooking area.

- There may be a cooler area in the centre of the cooktop between the cooking zones.
- You may need to move food around the pan to ensure even cooking.
- When using FlexZone it is not possible to use the PowerBoost function.

IMPORTANT!

When a FlexZone is activated, the entire zone will heat up. To avoid burns, ensure cutlery and magnetic items are never left on the cooktop.

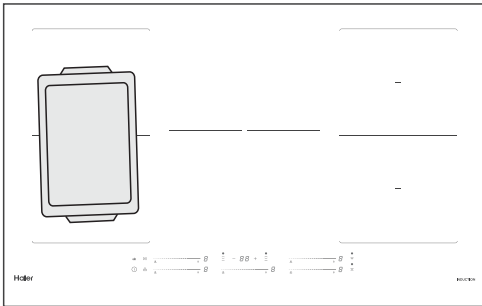

1. Place the pan over the two zones you wish to flex.



2. Choose either the front or back zone and select a power level.





3. While the power level display is blinking, hold  for 3 seconds until the indicator is on.

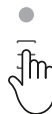

4. Adjust the power level pressing or sliding the front or back slider control.





5. To cancel Flexzone, select one of the cook zones. While the power level display is blinking, hold  for 3 seconds until  is no longer illuminated.

FEATURES

WARM FUNCTION

Use the warm function to maintain a gentle heat.





When the selected induction zone has heated, hold the end of the slider bar for 3 seconds until the display cycles through to  and then .

To exit Warm select any power level using the cook zone control.

POWER BOOST

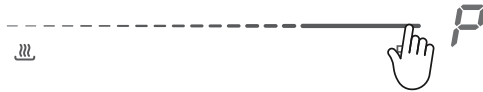
Use power boost to heat or boil quickly.



To heat or boil quickly, hold the end of the slider bar for 3 seconds or until  is displayed. Power boost will run for 5 minutes.

To exit power boost select any power level in the cook zone control.

USING THE TIMER

Setting the timer for a single cookzone



1. Select the cook zone and choose a power level. Press — or + control. 30 Minutes will show in the timer display and the selected cook zone will flash.

The timer will start after 30 seconds.

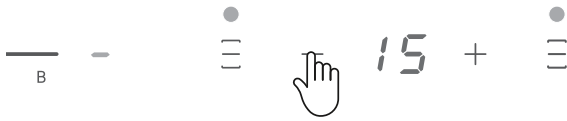

2. Adjust the time by activating the cooking zone and then pressing the — or + control. The timer will start after 3 seconds.



3. When the set time is up -- will flash, the timer will beep once and the zone will turn off.

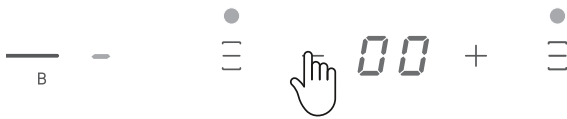

4. To cancel the timer, select the cook zone and press - on the cooking timer display until the display reaches 00.

Setting the timer for multiple cook zones.

1. Select a cook zone and choose a power level. While the zone is selected, press either + or - to activate the timer. 30 Minutes will show in the timer display and the selected cook zone will flash.
2. Adjust the time by tapping the — or + control. ☺ Will be illuminated next to the corresponding slider number.
3. Select the next cooking zone and when the zone is selected, press either + or - to start the timer. 30 Minutes will show in the timer display and ☺ is illuminated next to the corresponding slider number.
4. To check the time on a selected cook zone, select the cook zone and the timer display will show the remaining time.

- If you use this function to control more than one heating zone, the timer indicator will show the shortest time.
- If you want to check the set time of a heating zone, select the cook zone by pressing anywhere on the slider control. The timer display will show the remaining time for the selected cook zone.
- When the cooking time expires, the corresponding heating zone timer will beep once and automatically switch off.

WIFI/APP CONNECT

The SmartHQ app connects to your cooktop and contains useful information and tips.

The app ensures your Wi-Fi module firmware stays up to date, providing security and compatibility with your connected appliances.

Getting started

Connecting the cooktop to Wi-Fi for the first time may take up to 10 minutes. To prevent the cooktop automatically powering off while connecting, put a pot of water on one of the cooking zones and set it to power level 1.

On your mobile device:

1. Download the SmartHQ app.
2. Register and create an account.
3. Add your appliance and set up the Wi-Fi connection.

Connecting to your home Wi-Fi

1. Press and hold  until you hear a beep. When the cooktop has connected,  will stay illuminated.



Wifi indicator

What it means

 Fast flash (.25s) on/off

Appliance is ready to connect

 Slow flash (.5s) on/off

Appliance is re-connecting

 Constant illumination



Appliance is connected





HOB-TO-HOOD CONNECT

This feature enables a compatible Haier rangehood to be paired with your cooktop. The rangehood extraction speed automatically adjusts based on your cooktop power level.





Getting started

1. On your cook top press and hold  until you hear a beep. Then press and hold  on your rangehood. The LED indicator  will flash on and off while connecting and will stay illuminated (or flash slowly) once the two appliances are paired.

Hob-to-Hood LED Indicator	Cooktop	Rangehood	What it means
 Fast flash .25s on/off	Red	White	Appliance is ready to pair
 Slow flash .5s on/off	Red	White	Appliance is re-connecting
 Slow flash 3/.5s on/off	Red	White	Appliance is paired, rangehood is in Manual mode
 Constant illumination	Red	White	Appliance is paired, rangehood is in Auto mode

Manual Mode

When in Manual mode, the rangehood will not be automatically controlled by the cooktop. It remains paired and can be switched to Auto.

- To switch to Auto mode, press . The LED indicator  will be illuminated when the rangehood is in Auto.
- To switch back to Manual, press  again or select a different fan speed setting on the rangehood.

Auto Mode

The LED indicator  will be illuminated when the rangehood is in Auto mode. This mode allows the rangehood to be automatically controlled based on the cooktop power level.

- Pre-extraction: When the cooktop is powered on, the rangehood will automatically start at low fan speed. This helps improve the extraction performance
- During cooking: The rangehood speed will be automatically adjusted based on cooktop power level.
- Extraction+: When the cooktop is powered off after cooking, the rangehood will switch to Extraction+ and will continue operating for 5 minutes.

COOKING GUIDE

Induction heat settings

HEAT SETTING	SUITABILITY
	<ul style="list-style-type: none">• Warm
1 - 2	<ul style="list-style-type: none">• Gentle simmering• Slow warming
3 - 4	<ul style="list-style-type: none">• Reheating• Rapid simmering• Cooking rice
5 - 6	<ul style="list-style-type: none">• Pancakes
7 - 8	<ul style="list-style-type: none">• Pan-frying• Cooking pasta
9	<ul style="list-style-type: none">• Stir-frying• Searing• Bringing soup to the boil
B	<ul style="list-style-type: none">• Boiling water

The settings below are guidelines only. The exact setting will depend on several factors, including your cookware and the amount you are cooking. Experiment with the cooktop to find the settings that best suit you.

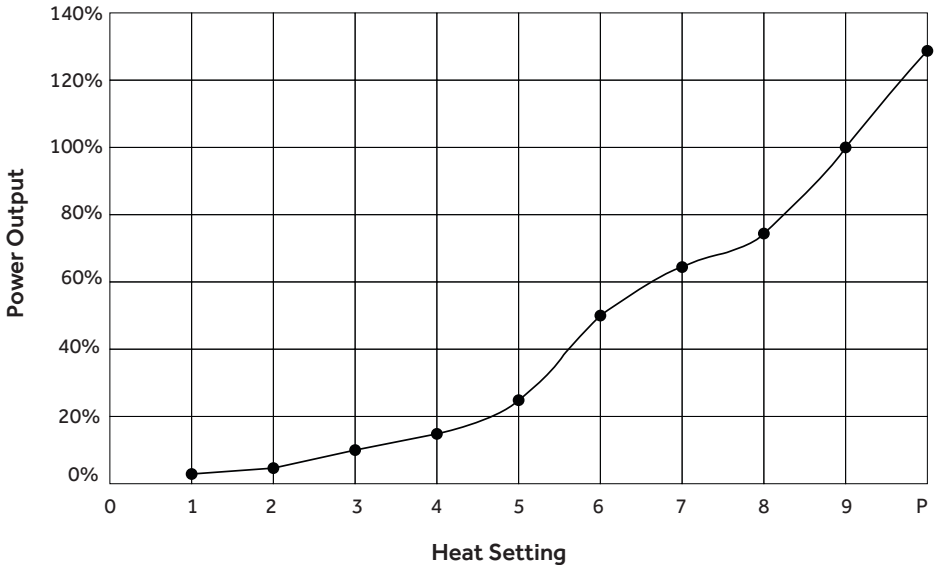

CARE AND CLEANING

WHAT?	HOW?	IMPORTANT!
<p>Everyday soiling on glass (fingerprints, marks, stains left by food or non-sugary spillovers on the glass)</p>	<ol style="list-style-type: none"> 1. Switch the power to the cooktop off at the wall. 2. Clean with soapy water and a damp cloth. 3. If soapy water and a damp cloth is unsuccessful, apply induction/ ceramic cooktop cleaner while the glass is still warm (but not hot) 4. Rinse and wipe dry with a clean cloth or paper towel. 5. Switch the power to the cooktop back on at the wall. 	<ul style="list-style-type: none"> • When the power to the cooktop is switched off, there will be no 'hot surface' indication but the cooking zone may still be hot! Take extreme care. • Heavy-duty scourers, some nylon scourers and harsh/ abrasive cleaning agents may scratch the glass. Always read the label to check if your cleaner or scourer is suitable. • Never leave cleaning residue on the cooktop: the glass may become stained.
<p>Boilovers, melts, and hot sugary spills on the glass</p>	<ol style="list-style-type: none"> 1. Remove these immediately with a knife or scraper suitable for ceramic glass cooktops, but beware of hot cooking zone surfaces. 2. Switch the power to the cooktop off at the wall. 3. Hold the blade or utensil at a 30° angle and scrape the soiling or spill to a cool area of the cooktop. 4. Clean the soiling or spill up with a dish cloth or paper towel. 5. Follow steps 2 to 4 for 'Everyday soiling on glass' above. 	<ul style="list-style-type: none"> • Remove stains left by melts and sugary food or spillovers as soon as possible. If left to cool on the glass, they may be difficult to remove or even permanently damage the glass surface. • Cut hazard: when the safety cover is retracted, the blade in a scraper is razor-sharp. Use with extreme care and always store safely and out of reach of children.
<p>Spillover on the touch controls.</p>	<ol style="list-style-type: none"> 1. Switch the power to the cooktop off at the wall. 2. Soak up the spill. 3. Wipe the touch control area with a clean damp sponge or cloth. 4. Wipe the area completely dry with a paper towel. 5. Switch the power to the cooktop back on at the wall. 	<ul style="list-style-type: none"> • The cooktop may beep and turn itself off, and the touch controls may not function while there is liquid on them. Make sure you wipe the touch control area dry before turning the cooktop back on.

TROUBLESHOOTING

PROBLEM	POSSIBLE CAUSES	WHAT TO DO
The induction cooktop cannot be turned on.	No power.	Make sure the induction cooktop is connected to the power supply and that it is switched on. Check whether there is a power outage in your home or area. If you've checked everything and the problem persists, call a qualified technician.
The touch controls are unresponsive.	The controls are locked.	Unlock the controls. See section 'Using your induction cooktop' for instructions.
The touch controls are difficult to operate.	There may be a slight film of water over the controls or you may be using the tip of your finger when touching the controls.	Make sure the touch control area is dry and use the ball of your finger when touching the controls.
The glass is being scratched.	Rough-edged cookware. Unsuitable, abrasive scourer or cleaning products being used.	Use cookware with flat and smooth bases. See 'Choosing the right cookware'. See 'Care and cleaning'.
Some pans make crackling or clicking noises.	This may be caused by the construction of your cookware (layers of different metals vibrating differently).	This is normal for cookware and does not indicate a fault.
The induction hob makes a low humming noise when used on a high heat setting.	This is caused by the technology of induction cooking.	This is normal, but the noise should quieten down or disappear completely when you decrease the heat setting.
Fan noise coming from the induction hob.	A cooling fan built into your induction hob has come on to prevent the electronics from overheating. It may continue to run even after you've turned the induction hob off.	This is normal and needs no action. Do not switch the power to the induction hob off at the wall while the fan is running.
Pans do not become hot and  appears in the display.	The induction hob cannot detect the pan because it is not suitable for induction cooking. The induction hob cannot detect the pan because it is too small for the cooking zone or not properly centred on it.	Use cookware suitable for induction cooking. See section 'Choosing the right cookware'. Centre the pan and make sure that its base matches the size of the cooking zone.

TROUBLESHOOTING

PROBLEM	POSSIBLE CAUSES	WHAT TO DO
The induction hob or a cooking zone has turned itself off unexpectedly, a tone sounds and an error code is displayed (typically alternating with one or two digits in the cooking timer display).	Technical fault.	Check the alert codes section in this guide. If a solution can not be found in the alert codes section, switch the power to the induction hob off at the wall, and contact a qualified technician.
Cooktop is beeping.	Too many cook zones are at high power.	Turn down one or more cook zones until the beeping stops.
	An object has been detected on the cooktop.	Remove the object from the cooktop.
Cooktop stopped operating during cooking.	Excessive temperature.	The hob will automatically shut down if there is excessive temperature. The fan will keep cooling down the induction hob for a further minute. When the hob has cooled, re-start cooking.
	An unsuitable size or non-magnetic pan (e.g. aluminium), or some other small item (e.g. knife, fork, key) has been left on the hob.	The cooktop will automatically go on standby for 1 minute. Remove items from cooktop.

CONNECT TO WIFI/APP

Wifi is not connecting	Not enough time allowed.	The connection process can take up to 10 minutes. Try to connect again.
	Internet connection is off or the network is bad.	Check that your modem is connected and working.

HOB-TO-HOOD

Hood does not stop when the cooktop is turned off.	This is normal.	The rangehood will continue to run for 5 minutes after the cooktop has been turned off unless in Manual.
Hood starts as soon as cooktop is turned on.	This is normal.	The rangehood will turn on as soon as the cooktop is powered on for maximum efficiency.
Hood is no longer in Auto.	The rangehood and hob have been disconnected and is in Manual.	Tap the Hob-to-Hood icon  on the cooktop to toggle back to Auto. The LED should be solid to indicate it is paired and in Auto.

AUTO SHUTDOWN PROTECTION - LONG COOKING OR COOKTOP LEFT ON

Power Level	1	2	3	4	5	6	7	8	9
Default shutdown (hours)	8	8	8	4	4	4	2	2	2

ALERT CODES

If an abnormality comes up, the induction cooktop will enter a protective state automatically and display corresponding fault codes:

PROBLEM	POSSIBLE CAUSES	WHAT TO DO
<i>F3</i>	Temperature sensor of the induction coil failure	Please contact customer care.
<i>F4</i>	Temperature sensor of the induction coil failure	Please contact customer care.
<i>F9</i>	Temperature sensor of the IGBT failure.	Please contact customer care.
<i>FA</i>	Temperature sensor of the IGBT failure.	Please contact customer care.
<i>E1</i>	Abnormal supply voltage	Please check whether the power supply is normal. Power on after the power supply has been checked and is operating normally
<i>E2</i>	Abnormal supply voltage	Please check whether the power supply is normal. Power on after the power supply has been checked and is operating normally
<i>E3</i>	High temperature of the induction coil temperature sensor	Please contact customer care.
<i>E4</i>	High temperature of the IGBT temperature sensor	Please restart after the hob cools down.

MANUFACTURER'S WARRANTY

Please read this warranty card carefully. Attach your purchase receipt to this warranty card and keep in a safe place. You must produce both warranty card and proof of purchase in the event of a warranty repair being required.

When you purchase any new Haier Product you automatically receive a two year Manufacturer's Warranty covering parts and labour for servicing.

The Manufacturer undertakes to:

Repair or, at its option, replace without cost to the owner either for material or labour any part of the Product, the serial number of which appears on the Product, which is found to be defective within TWO YEARS from the date of purchase.

This warranty DOES NOT cover:

- (A) Service calls which are not related to any defect in the Product. The cost of a service call will be charged if the problem is not found to be a Product related fault. For example:
 - ① Correct the installation of the product.
 - ② Provide Instruction on use of the product or change the setup of the product.
 - ③ Replace house fuses or correct house wiring.
 - ④ Correcting faults) caused by the user.
 - ⑤ Noise or vibration that is considered normal.
 - ⑥ Water on the floor due to incorrect loading or excessive suds.
 - ⑦ Blocked pumps, removal of foreign objects/substances from the machine, including the pump and inlet house filters.
 - ⑧ Correcting damage caused by pests, eg. rats, cockroaches etc.
 - ⑨ Correct corrosion or discolouration due to chemical attack.
 - ⑩ Power outages or surges.
- (B) Defects caused by factors other than:
 - ① Normal domestic use or
 - ② Use in accordance with the Product's User Guide.
- (C) Defects to the Product caused by accident, neglect, misuse or 'Act of God'.
- (D) The cost of repairs carried out by non-authorized repairers or the cost of correcting such unauthorised repairs.
- (E) Normal recommended maintenance as set out in the Product's User Guide.
- (F) Repairs when the appliance has been dismantled, repaired or serviced by other than an AUTHORISED CUSTOMER SERVICE CENTRE or the selling dealer.
- (G) Pick up and delivery.
- (H) Transportation or travelling costs involved in the repair when the product is installed outside the AUTHORISED CUSTOMER SERVICE CENTRE'S normal service area.

This product has been designed for use in a normal domestic environment. It is not intended for commercial use. Doing so may affect product warranty.

Service under this warranty must be provided by an Authorised Service Repairer (refer to the Customer Care section for contact details). Such service shall be provided during normal business hours. This warranty certificate should be shown when making any claim.

MANUFACTURER'S WARRANTY

Note:

This Warranty is an extra benefit and does not affect your legal rights and applies only to product purchased in New Zealand and Australia. Please keep this Warranty Card in a safe place.

For Australian customers:

Our goods come with guarantees that cannot be excluded under the Australian Consumer Law. You are entitled to a replacement or refund for a major failure and for compensation for any other reasonably foreseeable loss or damage. You are also entitled to have the goods repaired or replaced if the goods fail to be of acceptable quality and the failure does not amount to a major failure.

CUSTOMER SERVICE

We recommend our Haier Customer Service and the use of original spare parts.

If you have a problem with your appliance, please first check TROUBLESHOOTING. If you cannot find a solution there, please contact:

- Your local dealer.
- The Service & Support area at
www.haier.com.au or
www.haier.co.nz

where you can activate the service claim and also find FAQs.

To contact our Service, ensure that you have the following data available.
The information can be found on the rating plate at the door.

Model _____

Serial No. _____

Complete and keep for safe reference:

Model _____

Serial No. _____

Purchase Date _____

Purchaser _____

Dealer _____

Suburb _____

Town _____

Country _____

Haier

WWW.HAIER.COM.AU
WWW.HAIER.CO.NZ

条形码尺寸40*8mm, 由厂家生成。