



User manual
Washer-dryer

HWD9050AN1

Haier

NZ AU

Thank you for purchasing a Haier Product.

Please read these instructions carefully before using this appliance. The instructions contain important information which will help you get the best out of the appliance and ensure safe and proper installation, use and maintenance.

Keep this manual in a convenient place so you can always refer to it for the safe and proper use of the appliance.

If you sell the appliance, give it away, or leave it behind when you move house, make sure you also pass this manual so that the new owner can become familiar with the appliance and safety warnings.

Legend



Warning – Important Safety information



General information and tips



Environmental information

Disposal



Help protect the environment and human health. Put the packaging in applicable containers to recycle it. Help to recycle waste of electrical and electronic appliances. Do not dispose appliances marked with this symbol with the household waste. Return the product to your local recycling facility or contact your municipal office.



WARNING!

Risk of injury or suffocation!

Disconnect the appliance from the mains supply. Cut off the mains cable and dispose of it. Remove the door catch to prevent children and pets to get closed in the appliance.

1-Safety information.....	4
2-Product description.....	9
3-Control panel	10
4-Wi-Fi connection & Remote mode.....	14
5-Programmes.....	15
6-Consumption.....	16
7-Daily use.....	17
8-Eco-friendly washing	22
9-Care and cleaning	23
10-Troubleshooting	26
11-Installation.....	30
12-Technical data.....	34
13-Customer service.....	35

Before switching on your appliance for the first time, read and save this guide.



WARNING!

Before First Use

- ▶ Do not operate this machine if it has been damaged during transport. Contact your dealer or Haier service technician.
- ▶ Ensure all transport bolts are removed before running the appliance.
- ▶ Remove all packaging and keep out of reach of children.
- ▶ This appliance is heavy, we recommend 2 people to move and install the appliance.

Daily Use

- ▶ This appliance is not intended for use by persons (including children) with reduced physical, sensory or mental capabilities, or lack of experience and knowledge, unless they are supervised or given instructions on how to use the washer by someone responsible for their safety.
- ▶ Supervise children to ensure they do not play with the appliance or climb inside the drum.
- ▶ Do not use the appliance if industrial chemicals have been used for cleaning
- ▶ Store washing agents out of reach of children.
- ▶ Pull up zips, fix loose threads and take care for small items to prevent laundry from being entangled. If necessary, use an appropriate bag or net.
- ▶ Do not touch or operate the machine with wet hands or with bare-feet.
- ▶ Do not cover or encase the appliance during operation or afterwards to allow any moisture or dampness to evaporate.
- ▶ Do not place dripping wet clothing on top of the appliance as it may create an electrical hazard
- ▶ Do not use or store flammable detergent or dry cleaning agent in close vicinity to the appliance.
- ▶ Do not use any flammable sprays in close vicinity to the appliance.
- ▶ Do not wash any garments treated with solvents in the appliance without having dried them previously in the air.

**WARNING!****Daily Use**

- ▶ Do not remove or insert the plug in the presence of flammable gas.
- ▶ Do not hot wash foam rubber or sponge-like materials.
- ▶ Do not wash any laundry which is polluted with flour.
- ▶ Do not open detergent drawer during any wash cycle.
- ▶ Do not touch the door during the washing process, it gets hot.
- ▶ Do not open the door if the water level is visibly over the porthole.
- ▶ Do not force the door to open. The door is fitted with a self-lock device and will open shortly after the washing procedure is ended.
- ▶ Switch off the appliance after each wash programme and before undertaking any routine maintenance and disconnect the appliance from the electrical supply to save electricity and for safety.
- ▶ Hold the plug, not the cable, when unplugging the appliance.
- ▶ Do make sure the room is dry and well ventilated. The ambient temperature should be between 5 °C and 35 °C.
- ▶ Do not cover any ventilation openings in the base by a carpet or similar object.
- ▶ Keep the area around the appliance free of dust and lint.
- ▶ Do make sure that there is only laundry inside the appliance and no pets or children before you use it.
- ▶ Only dry textiles washed in water.
- ▶ Do make sure not to load more than nominal load.
- ▶ Remove all items such as lighters and matches from pockets.
- ▶ Use fabric softeners or similar products as specified by the manufacturer's packaging.
- ▶ Notice that the last part of the drying cycle occurs without heat (cool down cycle) to ensure the remaining garments are at a temperature which does not damage them.
- ▶ Do not leave the appliance unattended during run time for some time. If a long absence is intended, the drying cycle have to be interrupted by switching off the unit and unplugging the mains.
- ▶ Never stop a tumble dryer before the end of the drying cycle unless all items are quickly removed and spread out so that the heat is dissipated.



WARNING!

Daily Use

- ▶ Do not overload the appliance beyond its rated capacity

MAXIMUM WASH CAPACITY: 9 (KG)

MAXIMUM DRY CAPACITY: 5 (KG)

*Capacity refers to the maximum dry weight of items the appliance can dry at any one time

- ▶ Never stop a tumble clothes appliance before the end of the cool down/ airing phase of the cycle unless all items are removed and spread out in order to dissipate the heat.
- ▶ Do not dry following items in the appliance:
 - ▶ Items which are unwashed.
 - ▶ Items that have been soiled with substances such as cooking oil, acetone, alcohol, petrol, kerosene, spot removers, turpentine, waxes and wax removers should be washed in hot water with an extra amount of detergent before being dried in the appliance.
 - ▶ Items such as foam rubber (latex foam), shower caps, waterproof textiles, rubber backed articles and clothes or pillows fitted with foam rubber pads should not be dried in the appliance.
- ▶ Oil-affected items can ignite spontaneously, especially when exposed to heat sources such as a tumble appliance. The items become warm causing an oxidation reaction in the oil. This oxidation creates heat. If the heat cannot escape the items can become hot enough to catch fire. Piling, stacking or storing oil-affected items can prevent heat from escaping creating a fire hazard.
- ▶ If it is unavoidable that fabrics that contain vegetable oil, cooking oil or have been contaminated by hair care products be placed in the appliance, they should first be washed in hot water with extra detergent – this will reduce, but not eliminate the fire hazard. The cool down cycle of the appliance should be used to reduce the temperature of these items. They should not be removed from the tumble appliance and piled or stacked while hot.
- ▶ Fabric softeners, or similar products, should be used as specified by the fabric softener instructions.
- ▶ Remove all objects from pockets such as lighters and matches.

Switch off the appliance after each drying programme to save electricity and for safety.

Maintenance / cleaning

- ▶ Children should be supervised to ensure they do not play with the washer dryer.
- ▶ Disconnect the appliance from the electrical supply before undertaking any routine maintenance.
- ▶ Keep the lower part of the porthole clean and open door and detergent drawer if appliance is not in use to prevent odours.
- ▶ Do not use water spray or steam to clean the appliance.
- ▶ Do not try to repair the appliance by yourself. In case of repair please contact our customer service.
- ▶ Remove all foreign objects such as metal objects, chemicals, fragile goods, lighted candles, lighted cigarettes, etc. from the appliance.

Installation

WARNING: The appliance must not be supplied through an external switching device, such as a timer, or connected to a circuit that is regularly switched on and off by a utility.

- ▶ The appliance must not be installed behind a lockable door, sliding door, or a door with a hinge on the opposite side to the of the appliance, in such a way that a full opening of the appliance door could be restricted
- ▶ Install the appliance in a well-ventilated, dust-free environment.
- ▶ Do not install the appliance in a location where the ambient temperature drops below 5°C.
- ▶ Do not install the appliance outdoors, in a damp location, or in an area which is prone to water leaks. In the event of a water leak, unplug the appliance and allow it to dry naturally.
- ▶ Do not place the appliance directly on a carpet, or close to a wall or furniture.
- ▶ Do not expose the appliance to any frost, heat or direct sunlight or in the near of heat sources (e.g. stoves, heaters).
- ▶ Make sure that the electrical information on the rating plate agrees with the power supply. If it does not, contact an electrician

- ▶ Do not use multi-plug adapters and extension cables.
Install the appliance on a solid and level surface ensuring it has 20mm clearance on each side. The appliance must not be installed on any textured floor coverings (eg carpet, rugs).
- ▶ Make sure only the delivered electric cable and hose set are used.
- ▶ Make sure not to damage the electric cable and the plug. If damaged have it replaced by an electrician
- ▶ Use a separate earthed socket for the power supply which is easy accessible after installation. The appliance must be earthed.
- ▶ Make sure the hose joints and connections are firm and there is no leakage
- ▶ New hose sets provided with the appliance should be used to connect the washer to the water mains. Old hose sets should not be re-used.
- ▶ We recommend the inlet hose(s) are changed every 5 years.
WARNING:
Failure to do so may result in a flood and damage to property.
- ▶ Water supply requirements:
Inlet water pressure: Max. 1MPa (Xpsi), Min. 0.05MPa (Xpsi)
Inlet water flow rate: Min. 0.15 litres/minute
A pressure-reducing valve must be installed if pressure is higher than 1 MPa.
For optimum wash performance check the supply pressure is within the recommended range.

Servicing & Disposal

- ▶ A damaged electrical cable must be replaced by a Haier service technician or similarly qualified person. Do not use the appliance until it has been repaired.
- ▶ When disposing of the washer, it is recommended that the door is removed to avoid children getting trapped inside, and that the electrical cable is cut off close to the washer.

Intended use

This appliance is intended for washing and drying machine-washable laundry only. Anytime follow the instructions given on the label of each garment label. It is designed exclusively for domestic use inside the house. It is not intended for commercial or industrial use.

Changes or modifications to the device are not allowed. Unintended use may cause hazards and loss of of all warranty and liability claims.

i Note:

Due to technical changes and different models, the illustrations in the following chapters may differ from your model.

2.1 Picture of appliance

Front (Fig. 2-1):



Rear side (Fig. 2-2):

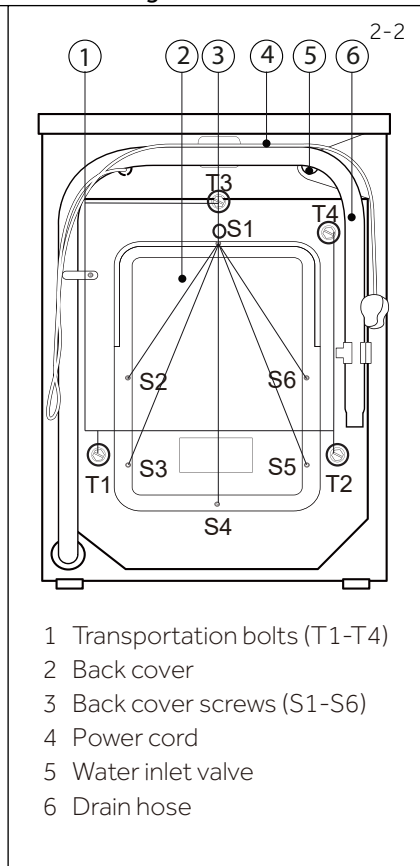

2.2 Accessories

Check the accessories and literature in accordance with this list (Fig. 2-3):

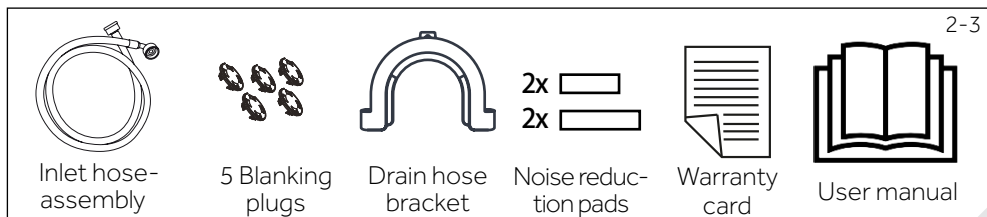

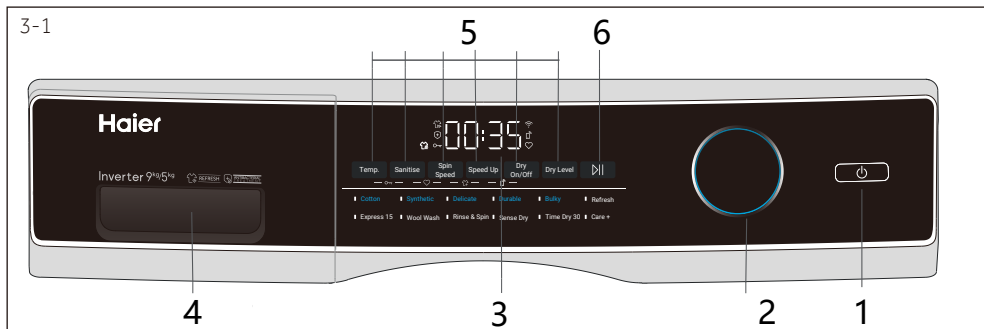

- | | | |
|----------------------|------------------------------|-------------------------|
| 1 "Power" button | 3 Display | 5 Function buttons |
| 2 Programme selector | 4 Detergent /softener drawer | 6 "Start /Pause" button |

i Note : Acoustic signal

In following cases, an acoustic signal is no sounds by default:

- ▶ when turning the programme selector

The acoustic signal can be selected if necessary ; see DAILY USE(see P21 7.13).

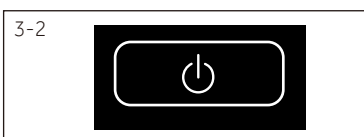

3.1 "Power" button

Touch this button (Fig. 3-2) gently to switch on, the display is shining. Press to turn the washer ON/OFF. Press and hold the Power button for five seconds until the Power is turned on and the APP will be displayed on the screen to turn on the network function.

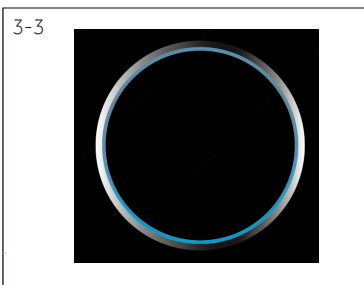

3.2 Programme selector

By turning the knob(Fig. 3-3), one of 12 programmes can be selected, related LED will light up, its default settings will be displayed.

3.3 Display

The display (Fig. 3-4) shows following information:

- ▶ Washing time
- ▶ End time delay
- ▶ Error codes and service information
- ▶ Function buttons and "Start/Pause" button
- ▶ Sanitise: Select sanitise function
- ▶ Temp: Select washing temperature
- ▶ Speed up: Select Speed up function
- ▶ Dry



3.4 Detergent drawer

Open dispenser drawer, the following components can be seen (Fig. 3-5):

1: compartment for powder or liquid detergent.

2: compartment for laundry aid products such as powder stain removers and soaking agents.

3: compartment for softener.

4: lock tab, press it down to pull out dispenser drawer. The recommendation on the type of the detergents is suitable for the various washing temperatures.

Please refer to the manual of detergent(see P15).

5: detergent flap sector, lift it up for powder detergent, keep it down for liquid detergent.

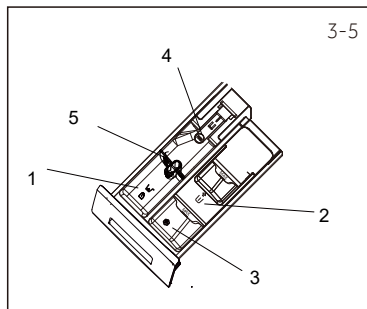

3.5 Function buttons

The function buttons (Fig. 3-6) enable additional options in the selected programme before the programme starts. The related indicators are displayed.

By switching off the appliance or setting up a new programme, all options are disabled.

If a button has multiple options, the desired option can be selected by pressing the button sequentially.

By pressing the buttons, the function is selected.



Note: Factory settings

To get the best results in each programme, Haier has well defined specific default settings. If there is no special requirement, default settings are recommended.

3.5.1-Function button "Temp."

Touch this button (Fig. 3-7) to change the washing temperature of the programme. If no value is illuminated (the display "--°C ") the water will not be heated.

3.5.2-Function button "Sanitise"

Touch this button (Fig. 3-8), sanitisation turns on during wash and rinses.

When selecting this function the temperature is set to 90°C .

3.5.3-Function button "Spin Speed"

Touch this button (Fig. 3-9) to change the spin speed of the programme. If "0" is selected, the laundry will not spin.

3.5.4 Function button "Speed up"

This function reduces washing time. Use for light soiled items. Available for the following cycles: Cotton, Synthetic, Delicate, Bulky, Durable, Care+. (Fig. 3-10)

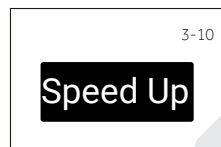
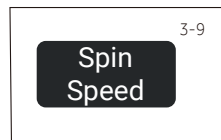
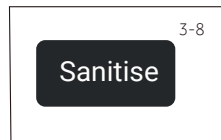
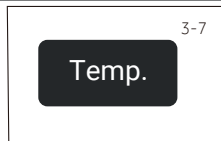

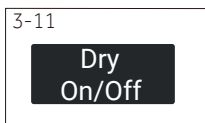

3.5.5 Function button "Dry On/Off"

Knob is in the "Dry+Wash" area, Perform default settings; Touch "Dry On/Off" button (Fig. 3-11), dry function will be switched off and only perform wash function.

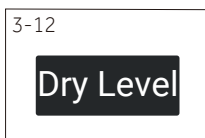

3.5.6 "Dry Level" button

Press this button (Fig.3-12) to change or deselect the dry level of the programme according to the needs.

L1 :Press Dry level button, the display L1,it means that clothes will be good for ironing after drying.

L2 (Default) :Press Dry level button, the display L2,it means that clothes can be directly worn after drying.

L3 :Press Dry level button, the display L3,it means that clothes can be stored directly after drying.

This function drying time can not be selected 30,60,90,120.



3.6 "Start/Pause" button

Press this button (Fig. 3-13) gently to start or interrupt the current programme. During programme setting and during programme run the LED above the button is shining, or if interrupted blinking.

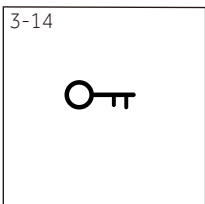

3.7 "Key lock"



Choosing a programme and then start, press button "Temp." and "Sanitise" (Fig.3-14) for 3 seconds simultaneously to block all panel elements against activation, panel display . For unlocking please press again the two buttons.The Key lock indicator lights up when the Key lock works. Feature is optional when the machine is running.

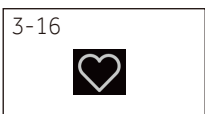

The display shows  (Fig. 3-15) if a button will be pressed, when the Key lock is activated. The change is not running.



3.8 Favourite

Choose a program and the desirable modifiers, then start the cycle. Press "Spin Speed" and "Sanitise" (Fig. 3-16) for 3 seconds simultaneously to save personalised options for available programme, panel displays . For restoring the default parameters for all programmes please select Express 15 programme and then touch button "Spin Speed", "Speed Up" and "Dry On/Off" for 3 seconds simultaneously, the display shows  (Fig. 3-17).

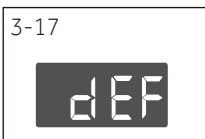

3.9 Add clothes halfway

Press the "Spin Speed" and "Speed Up" buttons at (Fig. 3-18) the same time, the washing machine will stop running (if the water level is high, it will automatically drain to a safe height and the door lock will open). At this time, open the door to add clothes, and press the "Start/Pause" button to continue running.

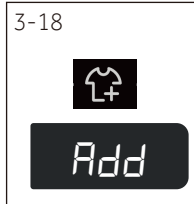

3.10 Program introduction

"Cotton", "synthetics", "Delicate", "Durable", "Bulky", After selecting these five blue programs, the default drying function is selected. If you don't need it, touch the "Dry On/Off" function key to cancel. Do only wash cycles.

"Refresh", "Express 15", "Wool Wash", "Rinse & Spin", only wash cycles are supported. "Sense Dry", "Time Dry 30", only dry cycles are supported.

Select "care+" program drying function to start by default, press Dry function key to cancel.



Your appliance can be connected to your home wireless network and operated remotely using the app.

Getting started

Ensure your home Wi-Fi network is turned on.

You will be given step by step guidance on both your appliance and mobile device.

It may take up to 10 minutes to connect your appliance.



On your mobile device:

1. Your product is Wi-Fi connectable. Please visit the webpage below to download the app and find out more:
Australia <https://www.haier.com.au/smart>
New Zealand <https://www.haier.co.nz/smart>
2. Register and create an account.
3. Add your appliance and set up the Wi-Fi connection

Connecting to your home Wi-Fi

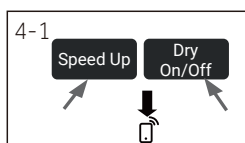
When your machine is connected to Wi-Fi successfully, the icon  lights up.



1. Press and hold **Speed Up** and **Dry on/off** combination keys for three seconds and the icon  lights up. **Remote Mode** is now enabled certain functions that your washer can now be accessed via the app . For disabling remote mode please touch again the two buttons, and the icon  goes out .

2. When turning off the washer, the Remote Mode will be automatically released. When the washer runs the programme in Remote Mode via app, the Remote Mode indicator  flashes every second.

• Yes, ◦ Optional, / No

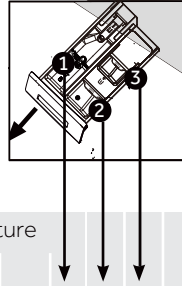

Detergent compartment for:

- 1 Powder Detergent/Liquid Detergent
- 2 Softener or care product
- 3 Prewash

Programme	Max. load		Temperature in °C ¹⁾	Preset				Fabrics type	Preset spin speed in rpm	Function			
	washing in kg	drying in kg			selectable range	1	2			3	Dry level	Sanitise	Temp.
Cotton	9	5	* to 90	20	•	•	•	Cotton	1400	•	•	•	•
Synthetics	9	3	* to 60	30	•	•	•	Synthetic or mixed fabric	1400	•	/	•	•
Delicate	2.5	1.5	* to 30	30	•	•	•	Delicate laundry and silk	600	•	/	•	•
Durable	9	5	* to 90	30	•	•	•	Cotton / Synthetic	1400	•	•	•	•
Bulky	9	5	* to 60	40	•	•	•	Cotton / Synthetic	1000	•	/	•	•
Refresh ³⁾	1	/	/	/	/	/	/	Cotton / Synthetic	/	/	/	/	/
Express 15 ²⁾	1	/	* to 40	*	•	•	•	Cotton / Synthetic	1000	/	/	•	/
Wool Wash	1	/	* to 40	*	•	•	•	Machine-washable fabric made of wool or with wool content	800	/	/	•	/
Rinse & Spin	9	/	/	/	/	•	•	Non-fragile fabric	1000	/	/	/	/
Sense Dry	/	5	/	/	/	/	/	Cotton / Synthetic	0	•	/	/	/
Time Dry 30	/	5	/	/	/	/	/	Cotton / Synthetic	/	/	/	/	/
Care +	4.5	3	* to 90	40	•	•	•	Cotton / Synthetic	1400	•	•	•	•

* Water is not heated up.

1) Choose 90°C wash temperature only for special hygienic requirements.

2) Reduce detergent amount because programme duration is short.

3) After using the Refresh program, clothes need to be dried because they are using steam to remove odors. Make sure the water pressure is up to standard and don't add washing powder or detergent.

Check the energy label for energy consumption information.

The actual energy consumption may differ from the declared one according to local conditions.

The warm wash eco cycle (Cotton, Dry :Off, 40 °C ,1400rpm, others are default setting.) is the recommended cycle for a normally soiled load equal to the rated load capacity (9kg). Actual water temperature may differ from declared cycle temperature.

Note: Auto Weight

The appliance is equipped with a loading recognition. At low loading, energy, water and washing time will be reduced automatically in some programmes. The display shows "AU EG".

General information and tips:

Standard programme for the Energy and Water Labelling according to AS/NZS 2040.2

Cotton, Dry :Off, 40 °C ,1400rpm, others are default setting.

When using standard program washing ,please use 80% standard detergent

Detergent dissolvent method: Dissolve the detergent first and pour the dissolved detergent into the machine when the main wash starts. The washing operation starts at the end of the first water filling.

Standard programme for the Energy saving cycle for drying labelling according to AS/NZS 2442.1

Sense Dry , 1400rpm, Dry Level: L3, others are default setting.

7.1. Power supply

Connect the washing machine to a power supply (220V to 240V~/50Hz; Fig. 7-1). Please refer also to section Installation.

7.2. Water connection

- ▶ Before connecting check the cleanliness and clarity of the water inlet.
- ▶ Turn on the tap (Fig.7-2).

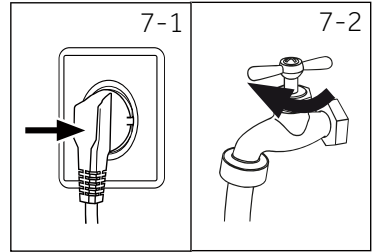

i Note: Tightness

Before use check for leakage in the joints between the tap and the inlet hose by turning on the tap.

7.3. Preparing laundry

- ▶ Sort out clothes according to fabric (cotton, synthetics, wool or silk etc.) and how dirty they are (Fig.7-3). Pay attention to the care labelling of washing labels.
- ▶ Separate white clothes from coloured ones. Wash coloured textiles first by hand to check if they fade or run.
- ▶ Empty pockets (keys, coins, etc.) and remove harder decorative objects (e.g. brooches) as well as flammable objects (paper tissues, lighters, matches etc.).
- ▶ Garments without hems, delicates and finely woven textile such as fine curtains are to be put into a wash bag to care for this delicate laundry (hand or dry cleaning would be better).
- ▶ Close zippers, velcro fastener and hooks, make sure the buttons are sewn on tightly.
- ▶ Place sensitive items like laundry without firm hem, delicate underwear (Dessous) and small items such as socks, belts, bras, etc. in a wash bag.
- ▶ Unfold large pieces of fabric such as bed sheets, bedspreads etc.
- ▶ Turn jeans and printed, decorated or color-intensive textiles inside out; possibly wash separately.

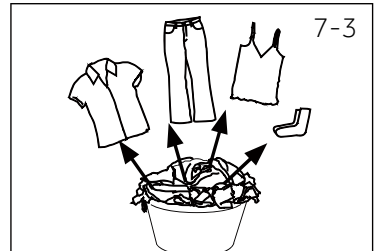

i Note: Special hints for drying

- ▶ Sort clothes according to fabric (cotton, synthetics, etc.) desired dry level and equal residual moisture. Follow the instructions on the laundry label and dry only machine-dryable garments
- ▶ Spin the laundry with the maximum spin speed before drying.
- ▶ Do not exceed the max. load.
- ▶ Extra large pieces tend to wind up. If the laundry has not been sufficiently dry, loosen up the laundry and dry again with programme Dry.
- ▶ Especially delicate fabrics which can easily shrink or lose their shape, as well as e.g. silk stockings, lingerie etc. should not be dried with the appliance. Put delicate garments inside a laundry bag and avoid overdrying them.
- ▶ Jersey and knitwear should not be dried to avoid shrinkage.

Care chart

Washing		
 Washable up to 95°C normal process	 Washable up to 60°C normal process	 Washable up to 60°C mild process
 Washable up to 40°C normal process	 Washable up to 40°C mild process	 Washable up to 40°C very mild process
 Washable up to 30°C normal process	 Washable up to 30°C mild process	 Washable up to 30°C very mild process
 Wash by hand max. 40°C	 Do not wash	
Bleaching		
 Any bleaching allowed	 Only oxygen/non-chlorine	 Do not bleach
Drying		
 Tumble drying possible normal temperature	 Tumble drying possible lower temperature	 Do not tumble dry
 Line drying	 Flat drying	
Ironing		
 Iron at a maximum temperature up to 200 °C	 Iron at a medial temperature up to 150°C	 Iron at a low temperature up to 110 °C; without steam (steam ironing may cause irreversible damage)
 Do not iron		
Professional Textile Care		
 Dry cleaning in tetra-chloroethene	 Dry cleaning in hydrocarbons	 Do not dry clean
 Professional wet clean	 Do not professional wet clean	

7.4 Loading the appliance

- ▶ Put in the laundry piece by piece.
- ▶ Don't overload. Note the different maximum load according to programmes! Rule of thumb for maximum load: Keep six inches between load and drum top.
- ▶ Close the door carefully. Make sure that no pieces of laundry are pinched.

**CAUTION!**

Non-textile, as well as small, loose or sharp-edged items may cause malfunctions and damage of clothes and appliance.

7.5 Selecting detergent

- ▶ Washing efficiency and performance is determined by used detergent quality.
- ▶ Use only machine wash approved detergent.
- ▶ If needed use specific detergents, e.g for synthetic and woolen fabric .
- ▶ See tips for countertop detergent stickers.
- ▶ Do not use dry cleaning agents such as trichloroethylene and similar products.

Choose the best detergent

Programme	Kind of detergent				
	Universal	Colour	Delicate	Special	Softener
Cotton	L/P	L/P	-	-	○
Synthetics	-	L/P	-	-	○
Delicate	-	-	L/P	L/P	○
Durable	-	L	-	L/P	○
Bulky	P	L/P	-	-	○
Refresh	-	-	-	-	○
Express 15'	-	L	-	-	○
Wool Wash	-	-	L/P	L/P	○
Rinse & Spin	-	-	-	-	○
Sense Dry	-	-	-	-	-
Time Dry 30	-	-	-	-	-
Care +	L/P	L/P	-	-	○

L = gel-/liquid detergent P = powder detergent O = optional -- = no
 If using liquid detergent, it is not recommended to activate the time delay.

We recommend by using:

- ▶ Laundry powder: 20°C to 90°C* (best use: 40-60°C)
- ▶ Color detergent: 20°C to 60°C (best use: 30-60°C)
- ▶ Wool/delicate detergent: 20°C to 30°C (best use: 20-30°C)

* Choose 90 °C wash temperature only for special hygienic requirements.

* If you choose the water temperature 60°C or above, we would like to advise you to use less detergent. Please kindly use the special disinfectant, which is suitable for cotton or synthetic cloth.

* It is better to use less or free suds detergent powder.

7-4

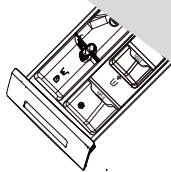

7.6 Add detergent

1. Slide out the detergent drawer.
2. Put the required chemicals into corresponding compartments (Fig. 7-4),
3. Push back the drawer gently.



Note:

- ▶ Remove detergent residues before next wash cycle from the detergent drawer.
- ▶ Do not overuse detergent or softener.
- ▶ Please follow the instruction on the detergent package.
- ▶ Always fill the detergent just before the beginning of the wash cycle.
- ▶ Concentrated liquid detergent should be diluted before adding.
- ▶ Do not use liquid detergent if function "Delay" is selected.
- ▶ Carefully choose the programme settings according to the care symbols on all laundry labels and according to the programme table.

7-5



7.7 Switch on the appliance

Touch the "Power" button to switch on the appliance (Fig. 7-5). The LED of the "Start/Pause" button is flashing.

7-6



7.8 Select a programme

To get the best washing results, select a programme which fits the degree of soiling and sort of laundry type.

Turn the programme knob (Fig. 7-6) to select the right programme. Related programme LED lights up and the default settings are displayed.



Note: Odour removal

Before first use we recommended to run programme "Cotton+90° C+600rpm" with no load and small amount of detergent in washing agent compartment (2) or special machine cleaner to remove possibly corruptive residues.

7-7



7.9 Add individual selections

Select required options and settings (Fig. 7-7); refer to Control Panel.

7.10 Start wash programme

Press "Start/Pause" button (Fig. 7-8) to start. The LED stops flashing and lights up continuously.

Appliance operates according to present settings.

Changes are only possible by cancelling the programme.

7.11 Interrupt / cancel wash programme

To interrupt a running programme press gently "Start/Pause". The LED above the button is flashing. Press it again to resume operation.

To cancel a running programme and all its individual settings:

1. Press "Start/Pause" button to interrupt the running programme.
2. Touch "Power" button for about 2 seconds to switch the appliance off.
3. Touch "Power" button to turn on the appliance. No select speed and run programme Spin to drain water.
4. After select a new programme and start it.

7.12 After washing



Note: Door lock

- ▶ For safety reasons the door is locked partially during the washing cycle. It is only possible to open the door at the end of the programme or after the programme was cancelled correctly (see description above).
- ▶ In case of high water level, high water temperature and during spinning it is not possible to open the door; **Loc L** is displayed.

1. At programme cycle end **End** is displayed.
2. The appliance switches off automatically.
3. Remove laundry as soon as possible to go easy on it and to prevent more wrinkling.
4. Turn off the water supply.
5. Unplug the power cord.
6. Open the door to prevent formation of moisture and odours. Let it open while not used.



Note: Standby-mode / energy -saving mode

The switched on appliance will go into standby-mode if it will not be activated within 2 minutes before starting the programme or at the end of programme. The display switches off. This save energy.



Note: Cool down cycle for drying cycle

The last part of the drying cycle occurs without heat to ensure remaining the garments at a temperature which does not damage them.

7.13 Activate or deactivate the buzzer

The acoustic signal can be deselected if necessary:

1. Switch on the appliance.
2. Select "Express 15" programme
3. Press the "Sanitise" button and "Speed Up" button at the same time for about 3 seconds. "**bEEP OFF**" will be displayed and the buzzer will be deactivated.

For activating the buzzer press these three buttons at the same time again. "**bEEP ON**" will be displayed.

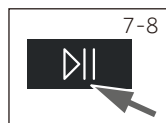



Environmentally responsible use

- ▶ To achieve best use of energy, water, detergent and time you should use the recommended maximum load size.
- ▶ Do not overload (hand width clearance above laundry).
- ▶ For slightly soiled laundry select the Express 15' programme.
- ▶ Apply exact dosages of each washing agent.
- ▶ Choose the lowest adequate washing temperature-modern detergents are efficiently cleaning below 60°C.
- ▶ Raise default settings only due to heavy staining.
- ▶ Spin the laundry with the maximum spin speed if you want to use a drying programme afterwards.

Drying

- ▶ Use the maximum filling amount of about 5 kg.
- ▶ Loosen up the laundry before starting the drying programme.
- ▶ Do not use softener when washing, because the laundry will become fluffy and soft in the dryer programme.

9.1 Cleaning the detergent drawer

Take always care there are no detergent residues. Clean the drawer regularly (Fig. 9-1):

1. Pull out the drawer until it stops.
2. Press the release button and remove the drawer.
3. Flush the drawer with water until it is clean and insert the drawer back in the appliance.

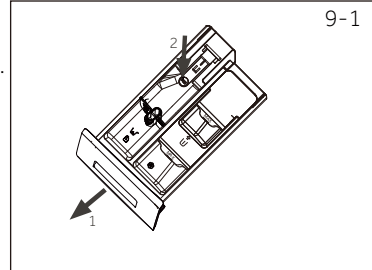

9.2 Cleaning the machine

- ▶ Unplug the machine during cleaning and maintenance.
- ▶ Use a soft cloth with soap liquid to clean the machine case (Fig. 9-2) and rubber components.
- ▶ Do not use organic chemicals or corrosive solvents.



9.3 Water inlet valve and inlet valve filter

To prevent blockage of water supply by solid substances like lime clean regularly the inlet valve filter.

- ▶ Unplug the power cord and turn off the water supply.
- ▶ Unscrew the water inlet hose at the back (Fig. 9-3) of the appliance as well as on the tap.
- ▶ Flush the filters with water and a brush (Fig. 9-4).
- ▶ Insert the filter and install the inlet hose.

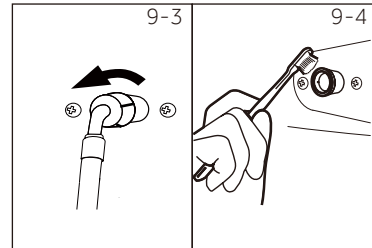

8.4 Cleaning the drum

- ▶ Remove accidentally washed items, especially metal parts such as pins, coins, etc. from the drum (Fig. 9-5) because they cause rust stains and damage.
- ▶ Use a non-chloride cleaner for removing rust stains. Observe the warning hints of the cleaning agent manufacturer.
- ▶ Do not use any hard objects or steel wool for cleaning.

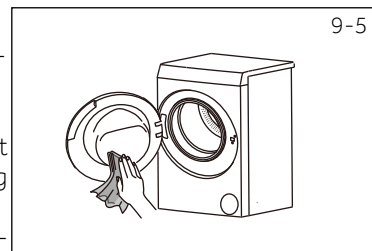

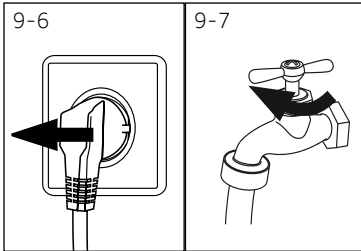

9.5 Long periods of disuse

If the appliance is left idle for a longer period:

1. Pull out the electrical plug (Fig. 9-6).
2. Turn off water supply (Fig. 9-7).
3. Open the door to prevent formation of moisture and odours. Let door open while not used.

Before next usage check carefully power cord, water inlet and drain hose. Make sure everything is properly installed and without leakage.

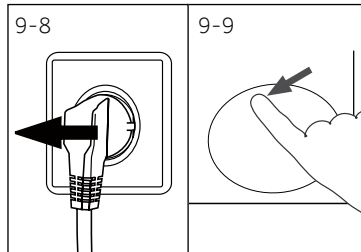

9.6 Pump filter

Clean the filter once a month and check the pump filter for instance if the appliance:

- ▶ Doesn't drain the water.
- ▶ Doesn't spin.
- ▶ Cause unusual noise while running.



WARNING!

Scalding Risk! Water in the pump filter can be very hot! Before any action please ensure water has cooled down.

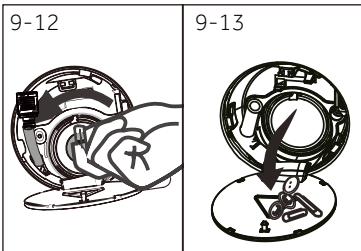
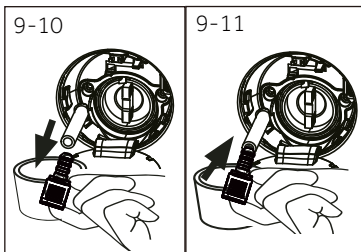

1. Turn off and unplug the machine (Fig. 9-8).
2. Push and open service flap (Fig. 9-9).
3. Provide a flat container to catch leach water (Fig. 9-10). There could be bigger amounts!
4. Pull the drainhose out and hold its end above the container (Fig. 9-10).
5. Take the sealing plug out of the drainhose (Fig. 9-10).
6. After complete drainage close drainhose (Fig. 9-11) and push it back into the machine.
7. Unscrew and remove counter clockwise the pump filter (Fig. 9-12).
8. Remove contaminants and dirt (Fig. 9-13).

9. Clean carefully pump filter, e.g. using running water (Fig. 9-14).
10. Refix it thoroughly (Fig. 9-15).
11. Close service flap.

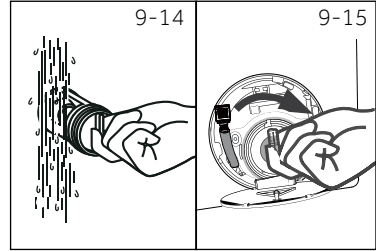

CAUTION!

- ▶ Pump filter sealing has to be clean and unhurt. If the lid is not full tightened, water can escape.
- ▶ The filter must be in place, or it may lead to leakage.
- ▶ Oil-affected items can ignite spontaneously, especially when exposed to heat sources, such as in a tumble dryer. The items become warm, causing an oxidation reaction in the oil. Oxidation creates heat. If the heat cannot escape, the items can become hot enough to catch fire. Piling, stacking or storing oil-affected items can prevent heat from escaping and so create a fire hazard.

If it is unavoidable that fabrics that contain vegetable or cooking oil or have been contaminated by hair care products be placed in a tumble dryer they should first be washed in hot water with extra detergent - this will reduce, but not eliminate, the hazard.

Many occurring problems could be solved by yourself without specific expertise. In case of a problem please check all shown possibilities and follow below instructions before you contact an after sales service. See CUSTOMER SERVICE.



WARNING!

- ▶ Before maintenance, deactivate the appliance and disconnect the mains plug from the mains socket.
- ▶ Electrical equipment should be serviced only by qualified electrical experts, because improper repairs can cause considerable consequential damages.
- ▶ A damaged power cable should only be replaced by the manufacturer, its service agent or similarly qualified persons in order to avoid a hazard.

10.1 Information codes

Following codes are displayed only for information referring to the washing cycle. No measures must be performed.

Code	Message
01:25	The remaining wash cycle time will be 1 hour and 25 minutes.
06:30	The remaining wash cycle time including chosen end-time delay will be 6 hours and 30 minutes.
AUTO	Automatic
End	The washing cycle is finished. The appliance shuts off automatically.
CLD L	Function child lock is activated.
Loc L	Door is closed because of high water level, high water temperature or spinning cycle.
bEEP OFF	The buzzer is deactivated.
bEEP ON	The buzzer is activated.

10.2 Troubleshooting with display code

Problem	Cause	Solution
CLr FLtr	<ul style="list-style-type: none"> • Drainage error, water is not fully drained within 6 minutes. 	<ul style="list-style-type: none"> • Clean pump filter. • Check drain hose installation.
door	<ul style="list-style-type: none"> • Lock error. 	<ul style="list-style-type: none"> • Shut the door properly.
E4	<ul style="list-style-type: none"> • Water level not reached after 8 minutes. • Drain hose is self-siphoning. 	<ul style="list-style-type: none"> • Make sure that tap is fully opened and water pressure is normal. • Check drain hose installation.
EE	<ul style="list-style-type: none"> • Water protective level error. 	<ul style="list-style-type: none"> • Contact the After sales service.

Problem	Cause	Solution
F3	<ul style="list-style-type: none"> Temperature sensor error. 	<ul style="list-style-type: none"> Contact the After sales service.
F4	<ul style="list-style-type: none"> Heating error. 	<ul style="list-style-type: none"> Contact the After sales service.
F7	<ul style="list-style-type: none"> Motor error. 	<ul style="list-style-type: none"> Contact the After sales service.
F9	<ul style="list-style-type: none"> Dry temperature sensor error. 	<ul style="list-style-type: none"> Contact the After sales service.
FR	<ul style="list-style-type: none"> Water level sensor error. 	<ul style="list-style-type: none"> Contact the After sales service.
FC1 or FC2 FC3	<ul style="list-style-type: none"> Abnormal communication error. 	<ul style="list-style-type: none"> Contact the After sales service.
Fd	<ul style="list-style-type: none"> Dry heating element error. 	<ul style="list-style-type: none"> Contact the After sales service.
FE	<ul style="list-style-type: none"> Dry motor error. 	<ul style="list-style-type: none"> Contact the After sales service.
E12	<ul style="list-style-type: none"> Drying water level is too high. 	<ul style="list-style-type: none"> Contact the After sales service.
Fb	<ul style="list-style-type: none"> Water overflowed abnormally. 	<ul style="list-style-type: none"> Contact the After sales service.
E5	<ul style="list-style-type: none"> Drainage error. Water is not fully drained within 1 minutes (Refresh programme). 	<ul style="list-style-type: none"> Clean pump filter. Check drain hose installation.

10.3 Troubleshooting without display code

Problem	Cause	Solution
Appliance fails to operate.	<ul style="list-style-type: none"> Programme is not yet started. Door is not properly closed. Machine has not been switched on. Power failure. Child lock is activated. 	<ul style="list-style-type: none"> Check programme and start it. Close the door properly. Switch the machine on. Check power supply. Deactivate child lock.
Appliance will not be filled with water.	<ul style="list-style-type: none"> No water. Inlet hose is kinked. Inlet hose filter is blocked. Water pressure is less than 0.03 MPa. Door is not properly closed. Water supply failure. 	<ul style="list-style-type: none"> Check water tap. Check inlet hose. Unblock inlet hose filter. Check water pressure. Close the door properly. Ensure the water supply.
Appliance is draining while being filled.	<ul style="list-style-type: none"> Height of drain hose is below 80 cm. Drain hose end could reach into water. 	<ul style="list-style-type: none"> Make sure that drain hose is properly installed. Make sure the drain hose is not in water.
Drainage failure.	<ul style="list-style-type: none"> Drain hose is blocked. Pump filter is blocked. Drain hose end is higher than 100 cm above floor level. 	<ul style="list-style-type: none"> Unblock drain hose. Clean pump filter. Make sure that drain hose is properly installed.

Problem	Cause	Solution
Strong vibration while spinning.	<ul style="list-style-type: none"> • Not all transportation bolts have been removed. • Appliance has no solid position. • Machine load is not correct. 	<ul style="list-style-type: none"> • Remove all transportation bolts. • Ensure solid ground and a levelled position. • Check load weight and balance.
Operation stops before completing wash cycle.	<ul style="list-style-type: none"> • Water or electric failure. 	<ul style="list-style-type: none"> • Check power and water supply.
Operation stops for a period of time.	<ul style="list-style-type: none"> • Appliance displays error code. • Problem due to load pattern. • Programme performs soaking cycle. 	<ul style="list-style-type: none"> • Consider display codes. • Reduce or adjust load. • Cancel programme and restart.
Excessive foam floats drum and/or detergent drawer.	<ul style="list-style-type: none"> • Detergent is not appropriate. • Excessive use of detergent. 	<ul style="list-style-type: none"> • Check detergent recommendations. • Reduce amount of detergent.
Automatic adjustment of washing time.	<ul style="list-style-type: none"> • Washing programme duration will be adjusted. 	<ul style="list-style-type: none"> • This is normal and doesn't affect functionality.
Spinning fails.	<ul style="list-style-type: none"> • Unbalance of laundry. 	<ul style="list-style-type: none"> • Check machine load and laundry and run a spinning programme again.
Unsatisfactory washing result.	<ul style="list-style-type: none"> • Degree of pollution does not agree with selected programme. • Detergent quantity was not sufficient. • Maximum load has been exceeded. • Laundry was unevenly distributed in the drum. 	<ul style="list-style-type: none"> • Select an other programme. • Choose the detergent according to the degree of pollution and the manufacturer specifications. • Reduce loading. • Loosen the laundry.
Washing powder residues are on the laundry.	<ul style="list-style-type: none"> • Insoluble particles of detergent can remain as white spots on the laundry. 	<ul style="list-style-type: none"> • Perform extra rinse. • Try to brush the points from the dry laundry. • Choose an other detergent.
Laundry has grey patches.	<ul style="list-style-type: none"> • Caused by fats such as oils, creams or ointments. 	<ul style="list-style-type: none"> • Pretreat the laundry with a special cleaner.



Note: Foam formation

If too much foam is inspected during spin cycle, motor stops and drain pump will be activated for 90 seconds. If that elimination of foam fails up to three times, programme ends without spinning.

Should the error messages reappear even after the taken measures, switch off the appliance, disconnect the power supply and contact the customer service.

10.4 In case of power failure

The current programme and its setting will be saved. When power supply is restored operation will be resumed.

If a power failure cuts an operating wash programme door opening is mechanically blocked. To get out any laundry water level should not be seen in the glassy porthole of the door. - Danger of burns! Water level has to be lowered as described in "Pump filter". Not till then pull lever (A) beneath service flap (Fig.10-1) until door is unlocked by a gentle click. Afterwards refix all parts.

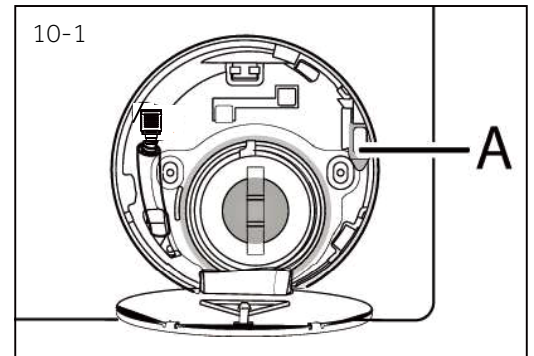

When the washing machine in a safe state (under the water level below the window along a certain distance, barrel temperature below 55°C, the inner barrel did not turn), may unlock the doors of the machine operation.

11.1 Preparation

- ▶ Take the appliance out of the packaging.
- ▶ Remove all packaging material including protecting film on cabinet, polystyrene base, keep them out of childrens reach. While opening the package, water drops may be seen on plastic bag and porthole. This normal phenomenon results from water tests in the factory.



Note: Packaging disposal

Keep all packaging materials out of children's reach and dispose them in an environmentally friendly manner.

11.2 OPTIONAL: Install noise reduction pads

1. When opening the shrink package, you will find four noise reduction pads. These are used for reducing noise (Fig. 11-1).
2. Lay the washing machine down to its side, porthole pointing upwards, bottom side towards operator.
3. Take out the noise reduction pads and remove the double-sided adhesive protective film; paste around the bottom; the noise reduction pads under the washing machine cabinet as shown in Figure 3 (two longer pads in position 1 and 3, two shorter pads in position 2 and 4). Finally set the machine upright again.

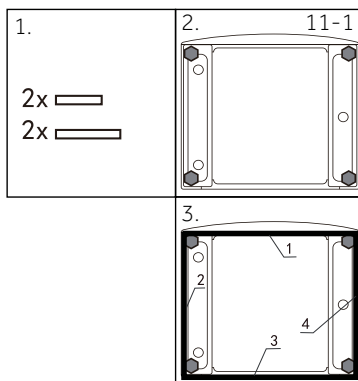

11.3 Dismantle the transportation bolts

The transportation bolts are designed for clamping anti-vibration components inside the appliance during transportation to prevent inner damage.

1. Remove all 4 bolts on the rear side and take out plastic spacers (Fig. 11-2)(Fig. 11-3).
2. Fill left holes with blanking plugs (Fig. 11-4)(Fig. 11-5).

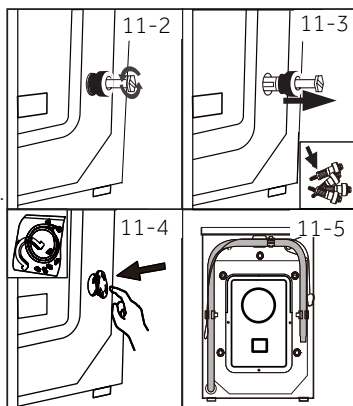



Note: Keep in safe place

- ▶ Keep all parts of the transport protection in a safe place for later use. Whenever the appliance is to be moved at first reinstall the protection parts.
- ▶ This appliance is intended to be used in household and similar applications such as:
 - staff kitchen areas in shops, offices and other working environments;
 - farm houses;
 - by clients in hotels, motels and other residential type environments;
 - bed and breakfast type environments;
 - areas for communal use in blocks of flats or in laundrettes.

11.4 Moving the appliance

If the machine is to be moved to a distant location, replace the transportation bolts removed before installation to prevent damage: The assembly takes place in reverse order.

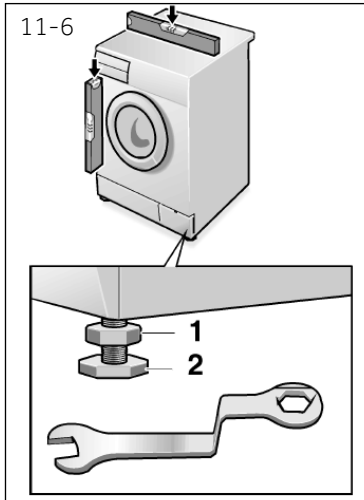

11.5 Aligning the appliance

Adjust all feet (Fig. 11-6) to achieve a complete level position. This will minimize vibrations and thus noise during use. It will also reduce wear and tear. We recommend to use a spirit level for adjustment. Floor should be as stable and flat as possible.

1. Loose the locknut (1) by using a wrench.
2. Adjust the high by turning the foot (2).
3. Tighten lock nut (1) against the housing.

11.6 Drain Water Connection

Fix the water drain hose properly to the piping. The hose has to reach at one point a height between 80 and 100 cm above the appliance bottom line! If possible keep always drain hose fixed to the clip at the appliance back.



WARNING!

- ▶ Use only the supplied hose set for the connection.
- ▶ Never reuse old hose sets!
- ▶ Only connect to cold water supply.
- ▶ Before connection, check whether the water is clean and clear.

Following connections are possible:

11.6.1 Drain hose to sink

- ▶ Hang the drain hose with the U-support over the edge of a sink with adequate size (Fig. 11-7).
- ▶ Protect the U-support sufficiently against slipping.

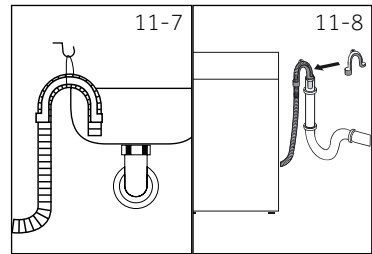

11.6.2 Drain hose to waste water connection

- ▶ The internal diameter of the stand pipe with vent-hole must be minimum 40 mm.
- ▶ Put the drain hose for 80-100mm in the wastewater pipe.
- ▶ Attach the U-support and secure it sufficiently (Fig. 11-8).

11.6.3 Drain hose to sink connection

- ▶ The junction must lie above the siphon.
- ▶ A spigot connection is usually closed by a pad (A). That must be removed to prevent any disfunction (Fig. 11-9).
- ▶ Secure the drain hose with a clamp.

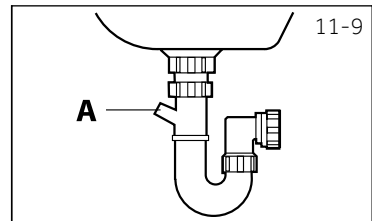

CAUTION!

- ▶ The drain hose should not be submerged in water and should be securely fixed and leak-free. If the drain hose is placed on the ground or if the pipe is at a height of less than 80 cm, the washing machine will continuously drain while being filled (self-siphoning).
- ▶ Drain hose is not to be extended. If necessary contact after sales service.

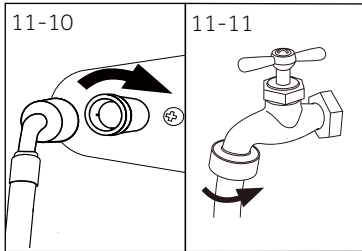

11.7 Fresh Water Connection

Make sure that the gaskets are inserted.

1. Connect the water inlet hose with the angled end to the appliance (Fig. 11-10). Tighten the screw joint by hand.
2. The other end connect to a water tap with a 3/4" thread (Fig. 11-11)

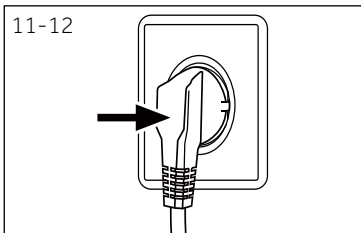

11.8 Electrical Connection

Before each connection check if:

- ▶ power supply, socket and fusing are appropriate to the rating plate.
- ▶ the power socket is earthed and no multi-plug or extension are used.
- ▶ the power plug and socket are strictly according.

Put the plug into the socket (Fig. 11-12).



WARNING!

- ▶ Ensure always that all connections (power supply, drain and fresh water hose) are firm, dry and leak free!
- ▶ Take care these parts are never to be crushed, kinked, or twisted.
- ▶ If the supply cord is damaged, it must be replaced by the service agent (see warranty card) in order to avoid a hazard.
- ▶ The appliance must not be supplied through an external switching device, such as a timer, or connected to a circuit that is regularly switched on and off by a utility.

11.1 Additional technical data

	HWD9050AN1
Voltage in V	220-240 V~/50Hz
Current in A	10
Max. power in W	1900
Water pressure in MPa	$0.05 \leq P \leq 1$
Net weight in kg	78

11.2 Product dimensions

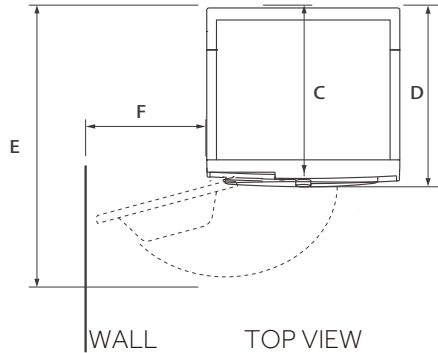
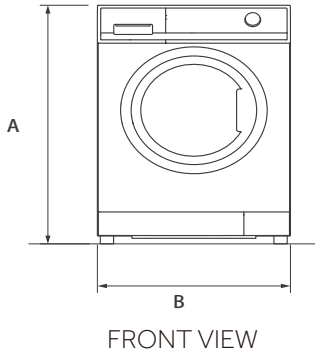

PRODUCT DIMENSIONS	HWD9050AN1
A Overall height of product mm	850
B Overall width of product mm	595
C Overall depth of product (To main control board size) mm	613
D Overall depth of product mm	688
E Depth of door open mm	1150
F Minimum door clearance to adjacent wall mm	270

Note: The exact height of your washer is dependent on how far the feet are extended from the base of the machine. The space where you install your washer needs to be at least 40mm wider and 20mm deeper than its dimensions.

11.3 Standards and Directives

This product meets the requirements of all applicable EC directives with the corresponding harmonised standards, which provide for CE marking.

We recommend our Haier Customer Service and the use of original spare parts.
If you have a problem with your appliance, please first check section TROUBLESHOOTING.

If you cannot find a solution there, please contact:

- ▶ your local dealer.
- ▶ the Service & Support area at www.haier.com where you can find telephone numbers and FAQs and where you can activate the service claim.

To contact our Service, ensure that you have the following data available.
The information can be found on the rating plate.

Model _____ Serial No. _____

Also check the Warranty Card supplied with the product in case of warranty.

For general business enquiries please contact our Customer Care Centre according to Warranty Card.

For more information please refer to www.haier.com.



Haier

0020507792AU