



USER GUIDE
HEAT PUMP CLOTHES DRYER

HDHP80AW1
HDHP80AWB1

NZ AU

Haier

Thank you for purchasing a Haier Product.

Please read these instructions carefully before using this appliance. The instructions contain important information which will help you get the best out of the appliance and ensure safe and proper installation, use and maintenance.

Keep this manual in a convenient place so you can always refer to it for the safe and proper use of the appliance.

If you sell the appliance, give it away, or leave it behind when you move house, make sure you also pass this manual so that the new owner can become familiar with the appliance and safety warnings.

Legend



Warning! – Important safety information



General information and tips



Environmental information

Disposal



Help protect the environment and human health. Put the packaging in applicable containers to recycle it. Help to recycle waste of electrical and electronic appliances. Do not dispose appliances marked with this symbol with the household waste. Return the product to your local recycling facility or contact your municipal office.



WARNING!

Risk of injury or suffocation!

Disconnect the appliance from the mains supply. Cut off the mains cable and dispose of it. Remove the door catch to prevent children and pets to get closed in the appliance.



WARNING!

The appliance must not be supplied through an external switching device, such as a timer, or connected to a circuit that is regularly switched on and off by a utility.

Safety information 4

Intended use..... 7

Product description..... 8

Control panel..... 9

Dry cycles.....13

Dry Preparation.....14

Getting started quickly.....16

Care and cleaning.....18

Before you call for service.....21

Fault codes.....22

Troubleshooting.....23

Installation.....26

Manufacturer's warranty.....29

Technical data.....30

Customer care.....31

Before switching on your appliance for the first time, read and save this guide.



WARNING!

Before use

- ~ Do not operate this machine if it has been damaged during transport. Contact your dealer or Haier service technician.
- ~ Ensure all transport bolts are removed before running the appliance.
- ~ Remove all packaging and keep out of reach of children.
- ~ This appliance is heavy, we recommend 2 people to move and install the appliance.

Daily use

- ~ This appliance is not intended for use by persons (including children) with reduced physical, sensory or mental capabilities, or lack of experience and knowledge, unless they are supervised or given instructions on how to use the dryer by someone responsible for their safety.
- ~ Supervise children to ensure they do not play with the appliance or climb inside the drum.
- ~ Do not touch or operate the machine with wet hands or with bare-feet.
- ~ Do not place dripping wet clothing on top of the appliance as it may create an electrical hazard.
- ~ Do not use the appliance if industrial chemicals have been used for cleaning. Ensure all lint filters are cleaned before every load.
- ~ The ambient temperature should be between 5 °C and 35 °C.
- ~ Do not cover any ventilation openings in the base by a carpet or similar object.
- ~ Keep the area around the tumble dryer free of dust and lint.
- ~ Do make sure that there is only laundry inside the appliance and no pets or children before you use it.
- ~ Only touch the mains plug with dry hands and do not touch or use the appliance if you are barefoot or have wet or damp hands or feet.
- ~ Only dry textiles washed in water.
- ~ Do not overload the appliance beyond its rated capacity.
- ~ Remove all items such as lighters and matches from pockets. Use fabric softeners or similar products as specified by the manufacturer's packaging.
- ~ Do not place heavy objects or sources of heat or damp on top of the appliance.
- ~ Hold the plug, not the cable, when unplugging the appliance.
- ~ Do not touch the rear wall and the drum during operation; they are hot.
- ~ If the lint filter is damaged, contact your Haier service technician to arrange getting a new filter. Do not operate your appliance with a damaged lint filter or without the filter in place, as this will cause damage to your appliance.
- ~ Do not operate this product without the lint filter in place or allow lint to accumulate in or around the appliance.



WARNING!

Daily use

- ~ Do not dry following items in the appliance:
 - ~ Items that have been soiled with substances such as cooking oil, acetone, alcohol, petrol, kerosene, spot removers, turpentine, waxes and wax removers should be washed in hot water with an extra amount of detergent before being dried in the appliance.
 - ~ Items such as foam rubber (latex foam), shower caps, waterproof textiles, rubber backed articles and clothes or pillows fitted with foam rubber pads should not be dried in the appliance.
- ~ Do not drink the condensed water.
- ~ Notice that the last stage of the drying cycle is a cool down and the dryer will run without heat for a few minutes to ensure that the garments are at a safe temperature to be taken out of the drum. If the cycle is paused during the drying stage, a cool down might take place. Garments may still feel hot to the touch- handle with care.
- ~ **WARNING:** Never stop a tumble dryer before the end of the drying cycle unless all items are quickly removed and spread out so that the heat is dissipated.
- ~ Switch off the appliance after each drying programme to save electricity and for safety.
- ~ Oil-affected items can ignite spontaneously, especially when exposed to heat sources such as a tumble appliance. The items become warm causing an oxidation reaction in the oil. This oxidation creates heat. If the heat cannot escape the items can become hot enough to catch fire. Piling, stacking or storing oil-affected items can prevent heat from escaping creating a fire hazard.
- ~ If it is unavoidable that fabrics that contain vegetable oil, cooking oil or have been contaminated by hair care products be placed in the appliance, they should first be washed in hot water with extra detergent – this will reduce, but not eliminate the fire hazard. The cool down cycle of the appliance should be used to reduce the temperature of these items. They should not be removed from the tumble appliance and piled or stacked while hot.

Maintenance / cleaning

- ~ Make sure children are supervised if they carry out cleaning and maintenance.
- ~ Disconnect the appliance from the electrical supply before undertaking any routine maintenance.



WARNING!

Maintenance / cleaning

- ~ Clean the lint filter and the condenser filter after each programme (refer to CARE AND CLEANING).
- ~ Do not use water spray or steam to clean the appliance.
- ~ Do not use industrial chemicals to clean the appliance.
- ~ Replace a damaged supply cord only by the manufacturer, its service agent or similarly qualified persons in order to avoid a hazard.
- ~ Do not try to repair the appliance by yourself. In case of repair please contact our customer service.

Installation

- ~ The appliance must not be installed behind a lockable door, sliding door, or a door with a hinge on the opposite side to the of the appliance, in such a way that a full opening of the appliance door could be restricted.
- ~ Install the appliance in a well-ventilated, dust-free environment.
- ~ Do not install the appliance outdoors, in a damp location, or in an area which is prone to water leaks. In the event of a water leak, unplug the appliance and allow it to dry naturally.
- ~ Do not install the appliance in a location where the ambient temperature drops below 5°C. If install the product in a low temperature room, and using the product continuously, there might be some water condensation and drops on floor.
- ~ Do not place the appliance directly on a carpet, or close to a wall or furniture.
- ~ Do not expose the appliance to any frost, heat or direct sunlight or in the near of heat sources(e.g. stoves, heaters).
- ~ Make sure that the electrical information on the rating plate agrees with the power supply. If it does not, contact an electrician.
- ~ Do not use multi-plug adapters and extension cables. Make sure not to damage the electric cable and the plug.
- ~ Use a separate earthed socket for the power supply which is easy accessible after installation. The appliance must be earthed.
- ~ WARNING: The appliance must not be supplied through an external switching device, such as a timer, or connected to a circuit that is regularly switched on and off by a utility.
- ~ Install the appliance on a solid and level surface ensuring it has 20mm clearance on each side. The appliance must not be installed on any textured floor coverings (eg carpet, rugs).

Servicing & Disposal

- ~ A damaged electrical cable must be replaced by a Haier service technician or

similarly qualified person. Do not use the appliance until it has been repaired.

- ~ The only user-removable parts of the appliance are the filters and drying rack. No other parts are designed to be removed by the user.
- ~ When disposing of the dryer, it is recommended that the door is removed to avoid children getting trapped inside, and that the electrical cable is cut off close to the dryer.

Intended use

This appliance is intended for drying items which have been washed in a water solution and are marked on the manufacturer’s care label as being suitable for tumble drying.

It is designed exclusively for domestic use inside the house. It is not intended for commercial or industrial use. Changes or modifications to the device are not allowed. Unintended use may cause hazards and loss of all warranty and liability claims.



Notice

The appliance contains the fluorinated greenhouse gas HFC-134a (GWP:1430). This gas is hermetically sealed.



Environmentally responsible use

- ~ **Thorough spin:** Spin the laundry with the maximum spin speed.
- ~ **Maximum load:** Use the maximum filling amount according to the program table, but do not overload the dryer.

MODEL	MAXIMUM CAPACITY (KG)
HDHP80AW1	8
HDHP80AWB1	8

*Capacity refers to the maximum dry weight of items the dryer can dry at any one time

- ~ **Loosen up the laundry:** Shake out the laundry before putting them into the dryer.
- ~ **Avoid excess drying:** An excessive drying should be avoided. Select the right programme and the appropriate dry level.
- ~ **Cleaning of the lint filters:** Clean the lint filters after each cycle.
- ~ **Ventilation:** Make sure the appliance is properly ventilated (refer to INSTALLATION).
- ~ **Condensed water reuse:** The collected condensed water can be used for the steam iron. Before it should be poured through a fine sieve or coffee filter paper. Smallest parts will be retained by the filter.

Notice

Due to technical changes and different models, the illustrations in the following chapters may differ from your model.

3.1 Picture of appliance Front (Fig. 3-1):

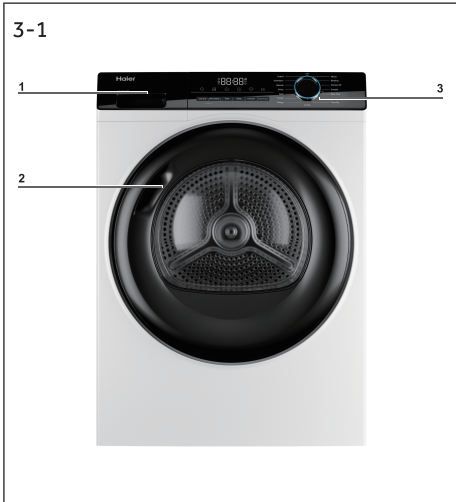

- 1 Water tank
- 2 Door
- 3 Control panel

Rear side (Fig. 3-2):

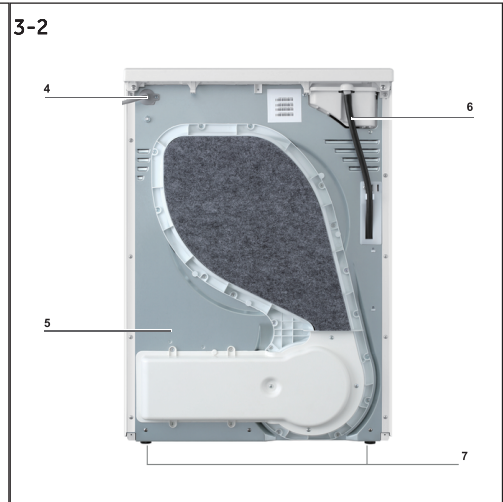

- 4 Power supply cord
- 5 Back plate
- 6 Drainage outlet
- 7 Adjustable feet

3.2 Accessories

Check the accessories and literature in accordance with this list (Fig.3-3):

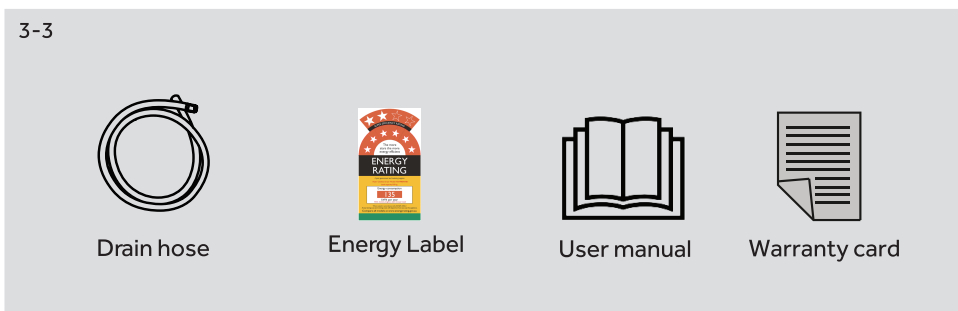

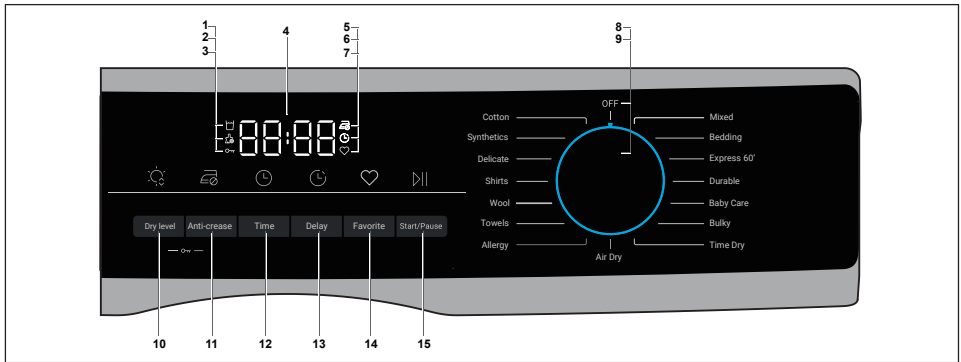

- | | | |
|--------------------------|----------------------|----------------|
| 1 Empty tank indicator | 7 Favorite indicator | 13 Delay |
| 2 Clean filter indicator | 8 OFF | 14 Favorite |
| 3 Keylock | 9 Control dial | 15 Start/Pause |
| 4 Digital display screen | 10 Dry Level | |
| 5 Anti-crease indicator | 11 Anti-crease | |
| 6 Delay indicator | 12 Time | |

4.1 Empty tank indicator

Water tank must be emptied (Fig. 4-1).
 Important: Empty the water tank after each drying cycle.
 See Empty the water tank section of the manual.



4.2 Clean filter indicator

Filters must be cleaned regularly. See Lint Filter Cleaning or Condenser Filter Cleaning section of the manual.



4.3 Keylock

Press and hold **Dry level** and **Anti-crease** combination keys for three seconds, the **Keylock** icon  light up on the panel. All buttons on the control panel excepting the **OFF** and keylock combi buttons are disabled. Repeat the operation to release the lock.

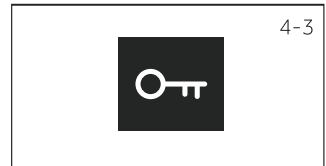

4.4 Digital display screen

Shows the following:

- Dry cycle options and machine settings
- Dry progress
- Notifications if an error is detected or warning is necessary.



4-5



4.5 Anti-crease indicator

Press the **Anti-crease** button to select the anti-crease function, then the **Anti-crease** indicator light up.

4-6



4.6 Delay indicator

When choose the delay program(Fig.4-6), It will light up.

4-7



4.6 Favorite mode

Press **Favorite** for three seconds, It will light up(Fig.4-7). The current program and setting function will be set to favorite mode, and the next time the program is selected, the favorite setting will be automatically called.Press and hold the **Delay** and **Favorite** keys for 3 seconds,clear all Favorite program settings,restore the factory default settings, and the  indication of all Favorite programs goes out.

4-8



4.8 OFF

Turn the knob to any position (except OFF) to start the machine. Turn knob the OFF position to shut down the machine(Fig. 4-8).

4-9



4.9 Control dial

Rotate to select your desired drying cycle.

4-10

Dry Level

4.10 Dry level

Press to select the level of dryness for your load. The corresponding dryness level of L-1, L-2 and L-3 are Damp, Dry and Extra dry.

4-11

Anti-crease

4.11 Anti-crease

Press to set **Anti-crease** function. When the cycle finishes, your dryer will beep and then turn off automatically. If the Anti-crease option has been selected, the drum will rotate periodically to minimise wrinkling and creasing. This is

particularly useful if you cannot remove the items immediately after the cycle ends.

4.12 Time

When a timed cycle is selected, using the **Time** button to adjust the time up or down. For timed cycles, the display will show approximately how many minutes the cycle has remaining. For automatic cycles, the word **AUTO** will appear on the screen.

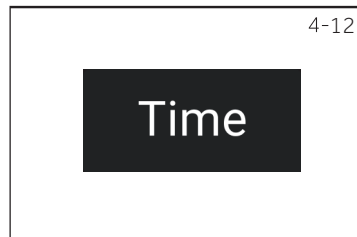



4.13 Delay

Delay function allows users to delay the start time of the cycle. Press the button (Fig. 4-13) to set the desired starting time (From 0 up to 12 hours). When activating, the indicator icon (Fig. 4-6) will light up.



4.14 Favorite

Before startup, it can be set. The setting method is to adjust the settings and press and hold the **Favorite** button for 3 seconds. After startup, it can't be set, including pause, drying, delay, end, and anti-crease phase.

After successfully setting favorite, there will be a sound prompt and the  icon will light up. (Fig. 4-7) The program after favorite is still valid after power off. The default program can also be favorite. If the program settings are not changed, perform the favorite operation again and still execute a valid favorite. Favorite has an overlay function, which allows you to continue setting new favorite settings on top of existing favorite programs. Press and hold the **Delay** and **Favorite** keys for 3 seconds, there is a prompt tone, and the digital display screen displays 'dEF' for 3 seconds. After 3 seconds, switch back to the program interface indicated by the knob, clear all favorite program settings, restore the factory default settings, and the  indication of all favorite programs go out.

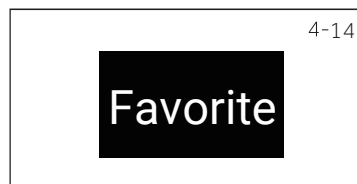

4.15 Start/Pause

Press to start or pause the selected dry cycle.



CYCLE	DEFAULT DRY LEVEL	DESIGNED FOR	MAX. LOAD SIZE (KG)
Cotton	Extra dry	Cotton garments	8
Synthetic	Dry	Synthetic garments	4
Delicate	Dry	Delicate and heat sensitive garments	2
Shirts	Dry	Suitable for conventional drying of cotton linen and polyester cotton blended shirts	4
Wool	n/a	For wool clothes	3
Towels	Extra dry	Towels	6
Allergy	Extra dry	Clothes that need to get rid of mites	2
Mixed	Extra dry	A cycle for mixed loads including cottons, synthetics and mixed fibres	5
Bedding	Extra dry	Large bedding items	4
Express 60'	n/a	A fixed 60 minutes dry	1
Durable	Extra dry	Durable garments	8
Baby Care	Extra dry	For baby clothes and underwear that needs high temperature to reduce allergens and bacteria	3
Bulky	Extra dry	Bulky items	2
Time Dry	n/a	A cycle with user selectable drying times	8
Air Dry	n/a	Freshness and deodorization of clothing	2

Cotton, Dry level H-2 program is the recommended energy saving cycle for everyday drying.
 DEFAULT DRY LEVEL : Extra dry — H - 3 ; Dry — H - 2 ; Damp — H - 1

Sorting

Sort items into loads of similar items, and loads that will likely take similar times to dry. This prevents the possibility of some items becoming over-dried whilst others are still damp.

Separate coloured items from white/light items where possible, especially when new. Colour run may be an issue, especially if you intend to delay the start of the drying cycle.

Care labels on garments provide valuable information about the fabric type and how the garment should be dried. Always follow the advice on garment labels.

ITEM/DRYING REQUIREMENTS	SUGGESTED CYCLE	COMMENTS
Towels	Towels	Towels produce a lot of lint and are best dried on their own.
Sheets, pillowcases	Bedding	Ensure openings are buttoned/domed before placing in the dryer.
Bulky items – doonas/duvets, sleeping bags and blankets	Bulky	Dry only one bulky item at a time.
Delicates, fine fabrics	Delicate	You can further reduce the dryness level to damp or use drying rack for very delicate items.
Hats and other odd shaped items	Rack Dry	Check on the item regularly throughout the drying cycle. Ensure the rack has been correctly fitted.
Bed linen, tea towels, socks, reusable face masks	Allergy	Ensure the items can safely withstand heat.
Mixed clothes	Cotton or Synthetic	Ensure the items can safely withstand heat.

Before you load

- Check pockets for items that could damage your clothes or get caught in the dryer. Close zippers, hooks and eyes, and other fastenings (ie fasten the openings of duvet/ doona covers), and remove loose bra wires. These may damage both your dryer and your clothes.
- Items of clothing with screen-printing should be turned inside out to prevent damage to the print.
- Check the lint filter is clean and the water tank is empty (if the dryer is not set up to drain automatically).

Loading

- Garments need to be loaded correctly to minimise creasing and wrinkling, and to ensure the load is dried evenly.
- Allow enough room in the dryer for clothes to tumble freely. Load the dryer in terms of the space the garments take up when dry, rather than when they are wet.
- Shake clothes out and load individually to help items dry evenly and reduce tangling.
- Dry permanent press garments (business shirts) together on the Damp dryness level with Anti-crease option on. This will help reduce wrinkling and the need for ironing.
- Hang garments as soon as the drying cycle is complete to reduce the need for ironing.

Drying times

- Drying very small loads is inefficient. Try to dry medium to large loads.
- Heavier items (towels, flannelette sheets) will take longer to dry than light items (synthetics and polyester cotton sheets and shirts).
- Drying times can be reduced by spinning the wash load at the highest spin speed suitable for the load type in your washing machine.
- Check bulky items during the cycle to ensure even drying, pause the dryer and reposition the item if necessary.

Lint

Some items are lint givers, while others are lint collectors. Always dry lint givers and collectors separately.

LINT GIVERS	LINT COLLECTORS
Towels	Synthetics, eg polar fleece
Flannelette sheets	Corduroy
	Polyester cottons

Delicate or easily damaged items (eg nylon stockings, fine fabrics, delicate embroidered fabrics) should be dried separately, using the **DELICATE** cycle, or if you do not want them tumbled use the **RACK DRY** cycle. Sleeping bags and other down items should be dried on **BULKY** cycle.

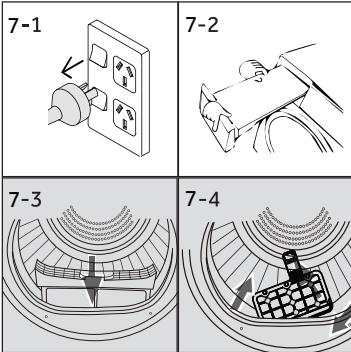

7.1 Preparing the appliance

1. Connect the appliance to a power supply(220V to 240V~/50Hz) .
2. Make sure:
 - the water tank is empty and properly installed. (Fig. 7-2).
 - the lint filter is clean and properly installed. (Fig. 7-3).
 - the condenser filter is clean and properly installed (Fig.7-4).

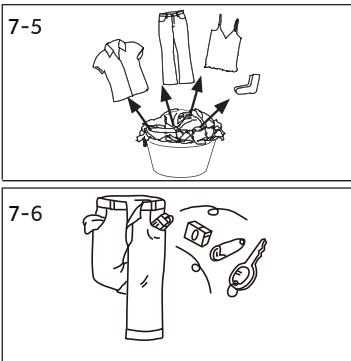

7.2 Preparing the laundry

- Sort clothes according to fabric (cotton,synthetics, wool etc.). Only dry laundry that has been spun.
- Empty pockets of all sharp or flammable objects such as keys and matches.
- Follow the instructions on the laundry label and dry loads that can be dried.

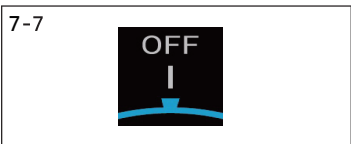

7.3 Activate the dryer

- Turn the knob to any position (except **OFF**) to start the machine.

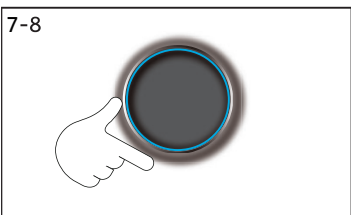

7.4 Set program

Select your desired drying cycle by turning the control dial.

(Set functions such as **Dry level**, **Delay**, **Anti-crease** and **Time**.)

7-9

A black rectangular button with the text "Start/Pause" in white.

7.5 Start the cycle

1. Press **Start/Pause** to start the cycle.

If you wish to change a cycle or select a different option once a drying cycle has started, you should shutdown and restart the dryer.

2. Press **Start/Pause** to restart the dryer with the new cycle.

7-10

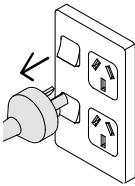

7.6 End of the cycle

Press **POWER** to turn off your dryer and unplug the dry.

When the cycle finishes, your dryer will beep and then turn off automatically. If the **Anti-crease** option has been selected, the dryer will rotate the drum periodically to help minimise wrinkling and creasing of your load.

If you wish to stop the dryer before the cycle has finished you **MUST** remove the clothes **IMMEDIATELY** and spread them out to cool. **DO NOT** leave the clothes in the dryer or bunched up in a clothes basket. Take extreme care as the drum and the load items may be extremely hot.

8-1

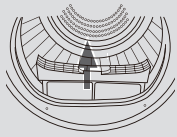

8.1 Lint filter cleaning

Clean the lint filter after each dry cycle.

1. Remove the lint filter from the drum (Fig. 8-1).

8-2

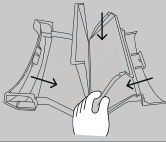

2. Open up the lint filter (Fig. 8-2).

8-3

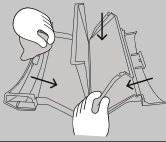

3. Clean the lint filter from any lint residuals (Fig. 8-3).

8-4

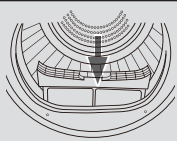

4. Reinstall the cleaned lint filter in the tumble dryer (Fig. 8-4).

8-5

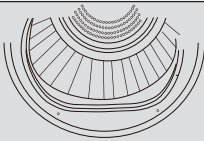

8.2 Condenser filter cleaning

Clean the lint filter after each dry cycle.

1. Open the door.

2. Pull out the lint filter from its housing (Fig. 8-5).

8-6

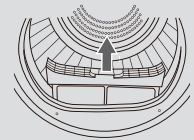

3. Pull out the condenser filter from the air duct (Fig. 8-6)

8-7

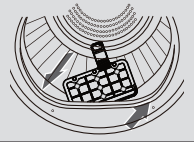

4. Remove the sponge and clean the filter screen from any residuals (Fig. 8-7).

8-8

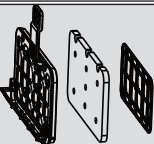

5. Reinstall the sponge to the condenser filter (Fig. 8-8)

8.3 Emptying the water tank

Empty the water tank after each drying cycle.

1. Pull out the water tank from its housing (Fig. 8-9).
2. Empty the water tank (Fig. 8-10).
3. Reinstall the water tank to the dryer (Fig. 8-11)

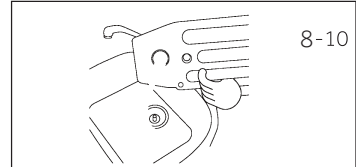

8.4 Clean the sensors

There are sensors in your dryer that detect whether the laundry is dry or not. These sensors need to be cleaned periodically (we recommend approximately four times a year).

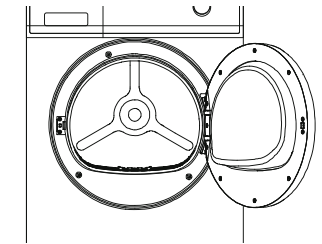

1. Open the door of your dryer. Allow the dryer to cool if drying has been carried out.

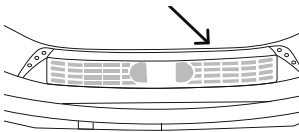

2. Locate the metal sensors just behind the lint filter.

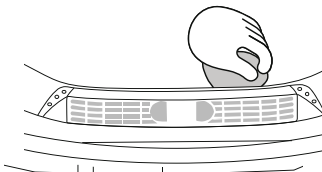

3. Wipe the sensors with a soft cloth, dampened with vinegar and dry with a clean dry soft cloth.

8.5 Clean the dryer

Wipe the outside of the tumble dryer and the control panel with a damp cloth. Do not use any organic solvent or corrosive agent to avoid damage to the device.

8.6 Clean the Drum

After some operation time, fabric care agents or calcium contained in the water can form an almost invisible film on the inside of the drum. Use a damp cloth and some detergent to remove it. Do not use any organic solvent or corrosive agent to avoid damage to the device.

User warnings

Your dryer is capable of diagnosing a number of its own problems. It will sound a continuous series of beeps and display a user prompt when it has a problem that you can correct yourself. To stop the beeping, touch any button on the control panel. Do not try to continue your drying cycle once you stop the noise. You must address the problem the dryer is alerting you to.

Check the below table before you call for service.

NOTIFICATION	WHAT TO DO
KEYLOCK ON	Touch and hold the Dry level and Sanitise combination button for three seconds to deactivate the Keylock.
CLEAN FILTERS AND EVAPORATOR GRID	Clean lint and condenser filters and carefully vacuum the evaporator grid. Check the lint filter or condenser filter are not damaged. Check there is nothing else trapped in the filters or evaporator grid, which may be blocking the air flow. Check the filters are correctly in place in your dryer.
WATER TANK	Check if the water tank is full. Empty the water tank. If using the drain hose, check whether the water tank or drain hose is blocked. Check the drain hose is still attached at the back of the machine, and is not kinked or squashed.
DOOR OPEN	Close the door fully and touch II. Try opening and closing the door again. Reposition the load, make sure the load is correctly in the drum and that protruding items are not preventing the door from closing.
THE LAUNDRY ENVIRONMENT IS TOO COLD FOR THE DRYER TO FUNCTION	The room temperature is too low for the heat pump system to work effectively. Ensure that the room temperature is above five degrees to avoid loss of efficiency.
MAXIMUM CYCLE TIME HAS BEEN REACHED	There are a number of reasons the maximum cycle time has been reached, refer to 'Troubleshooting', 'Dryer is taking too long.' for possible causes and solutions.

Once you have addressed the issue the user prompt was alerting you to, try using your dryer as per usual. If the issue persists, call your Fisher & Paykel trained and supported service technician.

When a continuous series of beeps sound, all the lights turn off on the control panel and a string of codes appears on the display, a fault has occurred. Please refer to the following instructions.

Code	Cause	Solution
F2	Drain pump failure / Water level switch failure	Contact the customer service.
F32 F33	The condenser thermal sensor is open-circuited or short-circuited.	Contact the customer service.
F4	Temperature of the laundry in the drum does not change.	Contact the customer service.
EE2	Communication failure between PCB and display.	Contact the customer service.
cLn both L InE FLtR	The lint filter is blocked and needs to be emptied.	Empty the lint filter and then replace it and check the lint filter is not damaged. Check there is nothing else stuck in the lint filter holder which may be blocking the air flow.
H20 FULL	The water tank is full and needs to be emptied.	Check and empty the water tank, if using drain hose, check whether the water tank or drain hose is blocked.
EE0	Communication failure of the display board itself	Contact the customer service.
EE	Filter clogging alarm	Open the door and clean the lint filters . After closing the door, press the start button to continue running the machine

PROBLEM	POSSIBLE CAUSES	WHAT TO DO
Small amount of water in the drum at end of cycle	Water tank needs to be emptied.	Refer to 'Emptying the water tank'.
	Environmental conditions may be affecting dryer operation.	If conditions are particularly hot, humid or cold, it is possible vaporised water may re-condense in the drum or on the inside of the door.
Noises	Dryer is overloaded.	Remove some items from the dryer.
	Dryer has a fault.	Continuous beeping or a musical series of beeps with a message displayed on the display. Refer to 'Fault codes'.
	Dryer Has not been levelled properly.	Adjust the adjustable foot under the dryer. Refer to 'Levelling the dryer'.
	Dryer makes unfamiliar noises.	At the start of the cycle the dryer may make some unfamiliar noises when the compressor turns on. This is normal.
Vibration	Dryer is not installed on a stable surface.	Ensure the dryer is installed on a flat, stable surface.
	Dryer is not level.	Ensure the dryer is correctly levelled.
	Dryer is overloaded.	Remove some items from the dryer.
Creasing	Cycle selection not appropriate for the load.	Choose appropriate cycle. Refer to 'Dry Cycles'
	Dryer is overloaded.	Remove some items from the dryer.
	Dry Level selected too high for load type.	Try selecting a lower Dry Level.
Dye transfer	White/light and coloured items not separated before drying.	Remember to separate white/light and coloured items before placing them in the dryer.
	Wet items left sitting in the dryer for long periods of time before drying.	Refer to 'Sorting' for tips to prevent dye transfer.

PROBLEM	POSSIBLE CAUSES	WHAT TO DO
Linting	Lint filter not cleaned or replaced.	Ensure the lint filter is cleaned after every cycle and replaced correctly. Refer to 'Cleaning the filters'.
	Loads not sorted correctly.	Dry lint-giving items separately from lint receivers. Also, dry similar colours together, eg light coloured items with light coloured items, dark items with dark items. Refer to 'Sorting'.
	Clothes over dried.	Over drying clothes in the dryer can cause them to attract lint. Use an auto sensing cycle or ensure you check your load if using the time dry cycles to avoid over drying.
Fabric damage	Instructions on care label not followed.	Follow the instructions on the care label of the items.
	DRYNESS LEVEL selected not appropriate for the fabric type.	Ensure the DRYNESS LEVEL selected is appropriate for the fabric type. Refer to the items care label. Refer to 'Drying rack'.
	Metal parts on the items or in the load.	Fasten zips and other clasps before placing items in the dryer.
	Items not separated or dried on an appropriate cycle for the fabric type.	Dry similar items together. Ensure an appropriate cycle is selected. Refer to 'Drying rack'.
	Items fell off the rack when using RACK DRY .	Ensure the rack is installed correctly (refer to 'Sorting', 'Drying rack') and only one or two garments are placed on the rack at a time.
	Used a TIME DRY cycle and did not monitor the dryness of clothes during the cycle.	Ensure that clothes are checked for dryness during the cycle when using the timed programmes to avoid over drying.

PROBLEM	POSSIBLE CAUSES	WHAT TO DO
<p>Tangling</p>	<p>Loads not separated during loading.</p>	<p>Try separating out larger items from smaller items.</p>
	<p>Items loaded into the dryer incorrectly.</p>	<p>Load items individually into the dryer. Do not place folded items in the dryer.</p>
	<p>Load size too large.</p>	<p>Try drying smaller load sizes. Some cycles have a lower maximum load size. Refer to 'Drying rack'.</p>
	<p>Delicate items not dried on RACK DRY.</p>	<p>Dry pantyhose, bras, stockings and any other delicate items prone to tangling on the RACK DRY cycle.</p>
	<p>Sheets and duvet/doona covers due to their size, are prone to tangling.</p>	<p>Dry sheets and duvet/doona covers separately from other laundry, apart from towels. Ensure duvet/doona covers are buttoned or fastened closed before drying. Try adding a knotted towel to sheets loads if you are experiencing a lot of tangling.</p>

Freestanding & Stacking

Your dryer can be installed one of two ways, either freestanding, or stacked on top of a Haier front loading washer.

1. The dryer stands on the floor and can easily be moved into position.
2. Your dryer has been designed to be able to be stacked on top of a Haier front loading washer. A stacking kit **MUST BE USED** between the products and fitted correctly to the washing machine and dryer, as per the stacking kit instructions.

Levelling the dryer

It is **IMPORTANT** to level the dryer to ensure the machine runs efficiently with minimal noise. The dryer should be levelled in as close to its final position as possible so it stands balanced evenly on all four feet. Ensure the dryer does not rock in any direction.

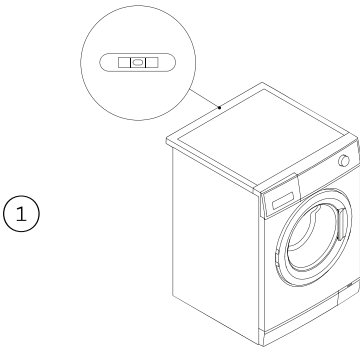

Level the dryer side to side:

- Place the level at the centre back of the dryer.
- Adjust the rear feet until the dryer is level side to side.
- Never unscrew the feet completely from their housings.

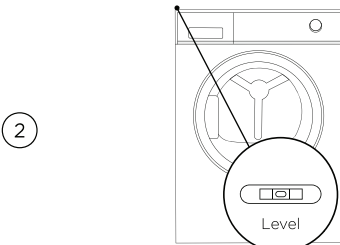

Level the dryer front to back:

- Place the level on the left side.
- Adjust the front left foot (wind down).
- Repeat the above for the right foot.
- There should be equal weight on both front feet.

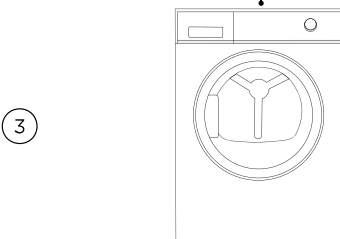

Re-check the dryer is level:

- Place the level at the centre front of the dryer
- Ensure dryer does not rock in any direction.
- If dryer is not level repeat the above steps.

After levelling, the corners of the dryer cabinet should be clear of the floor and the dryer must not rock in any direction.

Draining

The dryer is equipped with a condenser unit which accumulates water during the drying cycle. This water is collected in the removable water tank located at the top left of the dryer. The accumulated water must be emptied after each drying cycle or you can setup your dryer to drain automatically using the drain hose provided.

We recommend the dryer is set up to drain automatically where possible especially when drying full loads, this will avoid having to empty the water tank during a drying cycle.

Connecting the drain hose

①

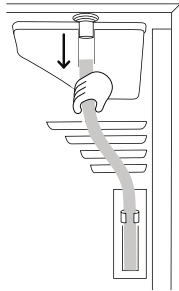

Remove the black hose from the connection at the back of the dryer.

②

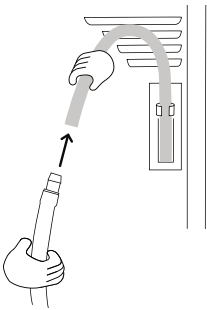

Uncoil the drain hose (included with your dryer) and connect it to the black hose.

③

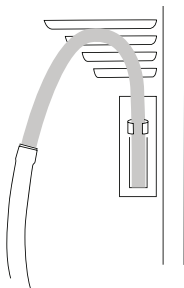

Place the other end of the drain hose into a tub or standpipe.

For New Zealand and Australia only. You automatically receive a 2 year Manufacturer's Warranty with the purchase of this heat pump clothes dryer covering parts and labour for servicing within the country of purchase.

Haier undertakes to:

Repair or, at its option, replace without cost to the owner either for material or labour any part of the product, the serial number of which appears on the product, which is found to be defective within TWO YEARS of the date of purchase.

Note: This Manufacturer's Warranty is an extra benefit and does not affect your legal rights.

This Manufacturer's Warranty DOES NOT cover

- Ⓐ Service calls which are not related to any defect in the product. The cost of a service call will be charged if the problem is not found to be a product fault.
For example:
 - ① Correcting the installation of the product.
 - ② Instructing you how to use the product.
 - ③ Replacing house fuses or correcting house wiring or plumbing.
 - ④ Correcting fault(s) caused by the user.
 - ⑤ Noise or vibration that is considered normal, eg drain/fan sounds, machine noises or user warning beeps.
 - ⑥ Correcting damage caused by pests, eg rats, cockroaches, etc.
 - ⑦ Poor drying performance due to incorrect installation and maintenance eg blocked lint filter, blocked condenser or full water tank.
 - ⑧ Poor drying performance due to incorrect loading, eg overloading or underloading.
 - ⑨ Damage from articles in the drum, eg bra wires, pens, crayons, dye transfer or flammable material.
- Ⓑ Defects caused by factors other than:
 - ① Normal domestic use;
 - ② Use in accordance with the product's User guide.
- Ⓒ Defects to the product caused by accident, neglect, misuse or 'act of God'.
- Ⓓ The cost of repairs carried out other than by a Fisher & Paykel trained and supported service technician or the cost of correcting such repairs.
- Ⓔ Normal recommended maintenance as set out in the product's User guide.
- Ⓕ Repairs when the appliance has been dismantled, repaired or serviced by other than a Haier trained and supported service technician or the selling dealer.
- Ⓖ Pick-up and delivery.
- Ⓗ Transportation or travelling costs involved in the repair when the product is installed outside the Haier trained and supported service technician's normal service area.

Nothing in this Manufacturer's Warranty is intended to, or does, limit any rights you may have under law to recover the costs of inspecting or returning the goods to us.

This product has been designed for use in a normal domestic (residential) environment. This product is not designed for commercial use (whatsoever). Any commercial use by a customer will affect this product's Manufacturer's Warranty.

Service under this Manufacturer's Warranty must be provided by a Haier trained and supported service technician (refer to the 'Before you call for service'). Such service shall be provided during normal business hours. This Manufacturer's Warranty certificate should be shown when making any claim.

For Australian Customers

This Manufacturer's Warranty is an extra benefit and does not affect your legal rights. Our goods come with guarantees that cannot be excluded under the Australian Consumer Law. You are entitled to a

replacement or refund for a major failure and for compensation for any other reasonably foreseeable loss or damage. You are also entitled to have the goods repaired or replaced if the goods fail to be of acceptable quality and the failure does not amount to a major failure.

Please keep this user guide in a safe place.

14 Additional technical data

Product dimensions

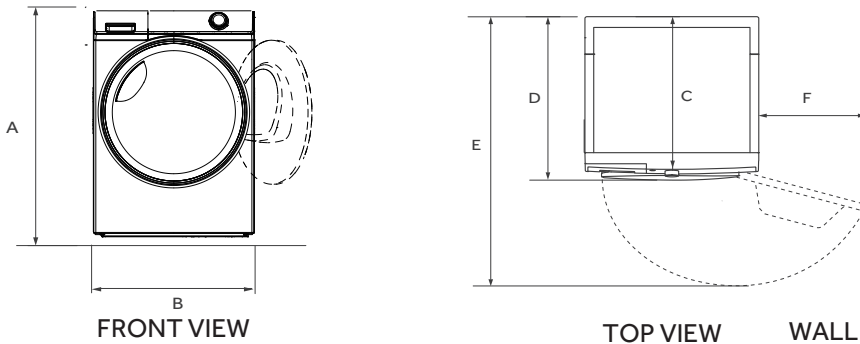

PRODUCT DIMENSIONS	
A Overall height of product mm	845
B Overall width of product mm	595
C Overall depth of product (To main control board size) mm	608
D Overall depth of product mm	658
E Depth of door open mm	1135
F Minimum door clearance to adjacent wall mm	250

Note: The exact height of your dryer is dependent on how far the feet are extended from the base of the machine. The space where you install your dryer needs to be at least 40mm wider and 20mm deeper than its dimensions.

We recommend our Haier Customer Service and the use of original spare parts.
If you have a problem with your appliance, please first check section TROUBLESHOOTING.

If you cannot find a solution there, please contact

- ~ your local dealer or
- ~ the Service & Support area at www.haier.com where you can find telephone numbers and FAQs and where you can activate the service claim.

To contact our Service, ensure that you have the following data available.
The information can be found on the rating plate.

Model _____ Serial No. _____

Also check the Warranty Card supplied with the product in case of warranty.

For general business requires please find below our addresses in New Zealand and Australia.

For more information, please refer to WWW.HAIER.COM.

HDHP80AW1/HDHP80AWB1

Haier



0180501350A