



User manual
Washer-Dryer

HWDX1590CTB1

Haier

NZ AU

Thank you for purchasing a Haier Product.

Please read these instructions carefully before using this appliance. The instructions contain important information which will help you get the best out of the appliance and ensure safe and proper installation, use and maintenance.

Keep this manual in a convenient place so you can always refer to it for the safe and proper use of the appliance.

If you sell the appliance, give it away, or leave it behind when you move house, make sure you also pass this manual so that the new owner can become familiar with the appliance and safety warnings.

Legend



Warning! – Important Safety information



General information and tips



Environmental information



Warning: Risk of fire/Flammable materials



Read the instructions

Disposal



Help protect the environment and human health. Put the packaging in applicable containers to recycle it. Help to recycle waste of electrical and electronic appliances. Do not dispose appliances marked with this symbol with the household waste. Return the product to your local recycling facility or contact your municipal office for advice on adequate disposal.

1-Safety information.....	4
2-Product description.....	9
3-Installation	10
4 -Technical data.....	14
5-Control panel	16
6-Wi-Fi connection & Remote mode.....	21
7-Cycles	24
8-Preparation & Daily Use.....	25
9- Eco-friendly washing.....	30
10-Care and cleaning.....	31
11-Troubleshooting	34
12-Customer service.....	38

Before switching on your appliance for the first time, read and save this guide.



WARNING!

Before First Use

- ▶ Do not operate this machine if it has been damaged during transport. Contact your dealer or Haier service technician.
- ▶ Ensure all transport bolts are removed before running the appliance.
- ▶ Remove all packaging and keep out of reach of children.
- ▶ This appliance is heavy, we recommend 2 people to move and install the appliance.
- ▶ This product has been designed for personal, family or household use. This product is not designed for any commercial use. Any commercial use will terminate this product's manufacturer's warranty.

Daily Use

- ▶ This appliance is not intended for use by persons (including children) with reduced physical, sensory or mental capabilities, or lack of experience and knowledge, unless they are supervised or given instructions on how to use the washer by someone responsible for their safety.
- ▶ Supervise children to ensure they do not play with the appliance or climb inside the drum.
- ▶ Do not swing on or put weight on the door.
- ▶ The appliance should only be used for garments recommended for machine washing/drying. Always follow the advice on the care label.
- ▶ Garments that contain metal reinforcements should not be placed in the appliance. If necessary, use an appropriate laundry bag or net.
- ▶ Do not use the appliance if industrial chemicals have been used for cleaning
- ▶ Store washing agents out of reach of children.
- ▶ Pull up zips, fix loose threads and take care for small items to prevent laundry from being entangled. If necessary, use an appropriate bag or net.
- ▶ Do not touch or operate the machine with wet hands or with bare-feet.

**WARNING!****Daily Use**

- ▶ Do not cover or encase the appliance during operation or afterwards to allow any moisture or dampness to evaporate.
- ▶ Do not place dripping wet clothing on top of the appliance as it may create an electrical hazard
- ▶ Do not add petrol, dry-cleaning solvents, perfumes or other flammable or explosive substances to the wash water. These substances give off vapours that could ignite or explode.
- ▶ Do not wash articles that have been previously cleaned in, washed in, soaked in, or spotted with gasoline, dry-cleaning solvents, or other flammable or explosive substances as they give off vapours that could ignite or explode.
- ▶ Do not wash an electric blanket in your washer unless the care label specifically states it is safe to do so.
- ▶ Fabric softeners, or similar products, should be used as specified by the manufacturer instructions
- ▶ Do not remove or insert the plug in the presence of flammable gas.
- ▶ Do not hot wash foam rubber or sponge-like materials.
- ▶ Do not wash any laundry which is polluted with flour.
- ▶ The appliance & door might get hot during operation, use caution if in close proximity & keep children away from the appliance.
- ▶ Do not open the door if the water level is visibly over the porthole.
- ▶ Do not force the door to open. The door is fitted with a self-lock device and will open shortly after the washing procedure is ended.
- ▶ Switch off the appliance after each wash programme and before undertaking any routine maintenance and disconnect the appliance from the electrical supply to save electricity and for safety.
- ▶ Hold the plug, not the cable, when unplugging the appliance.
- ▶ Do make sure the room is dry and well ventilated. The ambient temperature should be between 5 °C and 35 °C.
- ▶ Keep the area around the appliance free of dust and lint.
- ▶ Do make sure that there is only laundry inside the appliance and no pets or children before you use it.



WARNING!

Daily Use

- ▶ Only dry textiles washed in water.
- ▶ Do make sure not to load more than nominal load.
- ▶ Remove all items such as lighters and matches from pockets.
- ▶ Use fabric softeners or similar products as specified by the manufacturer's packaging.



WARNING: The last stage of the drying cycle is a cool down phase. Never stop a tumble clothes appliance before the end of the cycle unless all items are removed and spread out in order to dissipate the heat.

- ▶ Do not leave the appliance unattended during run time for some time. If a long absence is intended, the drying cycle have to be interrupted by switching off the unit and unplugging the mains.
- ▶ Do not overload the appliance beyond its rated capacity

MAXIMUM WASH CAPACITY: 15 (KG)

MAXIMUM DRY CAPACITY: 9 (KG)

*Capacity refers to the maximum dry weight of items the appliance can wash/dry at any one time

- ▶ Do not dry following items in the appliance:
 - ▶ Do not dry Items which are unwashed.
 - ▶ Do not dry items which have been cleaned with industrial chemicals.
 - ▶ Items that have previously been cleaned in, washed in, soaked in or spotted with flammable liquids or solids, eg petrol/gasoline, kerosene, dry cleaning solvents, vegetable or cooking oil, acetone, denatured alcohol, some brands of spot removers, turpentine, waxes and wax removers or other flammable or explosive substances should not be placed in a tumble dryer.
 - ▶ Rubber backed articles, foam rubber (latex foam), clothes or pillows fitted with foam rubber pads, fibreglass, shoes containing rubber, plastic, shower caps, babies waterproof napkin covers and waterproof textiles should not be dried in the dryer. These materials can when heated produce fire by spontaneous combustion.
 - ▶ Do not dry an electric blanket or any other electrical items in your dryer, unless the care label specifically states it is safe to do so. Never dry these items at high temperatures.

- ▶ Oil-affected items can ignite spontaneously, especially when exposed to heat sources such as a tumble appliance. The items become warm causing an oxidation reaction in the oil. This oxidation creates heat. If the heat cannot escape the items can become hot enough to catch fire. Piling, stacking or storing oil-affected items can prevent heat from escaping creating a fire hazard.
- ▶ If it is unavoidable that fabrics that contain vegetable oil, cooking oil or have been contaminated by hair care products be placed in the appliance, they should first be washed in hot water with extra detergent- this way reduce, but not eliminate the fire hazard. The cool down cycle of the appliance should be used to reduce the temperature of these items. They should not be removed from the tumble appliance and piled or stacked while hot.

Maintenance & cleaning

- ▶ Disconnect the appliance from the electrical supply before undertaking any routine maintenance.
- ▶ A damaged electrical cable must be replaced by a Haier service technician or similarly qualified person. Do not use the appliance until it has been repaired to avoid a risk of electric shock.
- ▶ When disposing of the appliance, it is recommended that the door is removed to avoid children getting trapped inside and that the electrical cable is cut off close to the machine .
- ▶ Keep the gasket, dispenser & door clean to prevent odours.
- ▶ Do not use water spray or steam to clean the appliance.
- ▶ Do not try to repair the appliance by yourself. In case of repair, please contact our customer service.

Installation



WARNING! Electric Shock Hazard Failure to follow this advice may result in electric shock or death.

The appliance must not be supplied through an external switching device, such as a timer, or connected to a circuit that is regularly switched on and switched on and off by a utility.

- ▶ The appliance must not be installed behind a lockable door, sliding door, or a door with a hinge on the opposite side to the of the appliance, in such a way that a full opening of the appliance door could be restricted.
- ▶ Install the appliance in a well-ventilated, dust-free environment
- ▶ Do not install the appliance in a location where the ambient temperature drops below 5°C.
- ▶ Do not install the appliance outdoors, in a damp location, or in an area which is prone to water leaks. In the event of a water leak, unplug the appliance and allow it to dry naturally.
- ▶ Do not place the appliance directly on a carpet, or close to a wall of furniture.

- ▶ Do not use multi-plug adapters and extension cables.
Warning: Install the appliance on a solid and level surface ensuring it has 20mm clearance on each side. The appliance must not be installed on any textured floor coverings (eg carpet, rugs).
- ▶ Make sure only the delivered electric cable and hose set are used.
- ▶ Make sure not to damage the electric cable and the plug. If damaged have it replaced by an electrician
- ▶ Use a separate earthed socket for the power supply which is easy accessible after installation. The appliance must be earthed.
- ▶ Make sure the hose joints and connections are firm and there is no leakage
- ▶ New hose sets provided with the appliance should be used to connect the washer to the water mains. Old hose sets should not be re-used.
- ▶ We recommend the inlet hose(s) are changed every 5 years.
WARNING:
Failure to do so may result in a flood and damage to property.
- ▶ Water supply requirements:
Inlet water pressure: Max. 1MPa (Xpsi), Min. 0.05MPa (Xpsi)
Inlet water flow rate: Min. 6 litres/minute
A pressure-reducing valve must be installed if pressure is higher than 1 MPa.
For optimum wash performance check the supply pressure is within the recommended range.
- ▶ The appliance has a glass top panel, please avoid placing & dropping items on top panel.

Servicing & Disposal

- ▶ A damaged electrical cable must be replaced by a Haier service technician or similarly qualified person. Do not use the appliance until it has been repaired.
- ▶ When disposing of the washer, it is recommended that the door is removed to avoid children getting trapped inside, and that the electrical cable is cut off close to the washer.

Intended use

This appliance is intended for washing and drying machine-washable laundry only. Anytime follow the instructions given on the label of each garment label. It is designed exclusively for domestic use inside the house. It is not intended for commercial or industrial use.

Changes or modifications to the device are not allowed. Unintended use may cause hazards and loss of of all warranty and liability claims.

i Note:

Due to technical changes and different models, the illustrations in the following chapters may differ from your model.

2.1 Picture of appliance

Front (Fig. 2-1):

Rear side (Fig. 2-2):

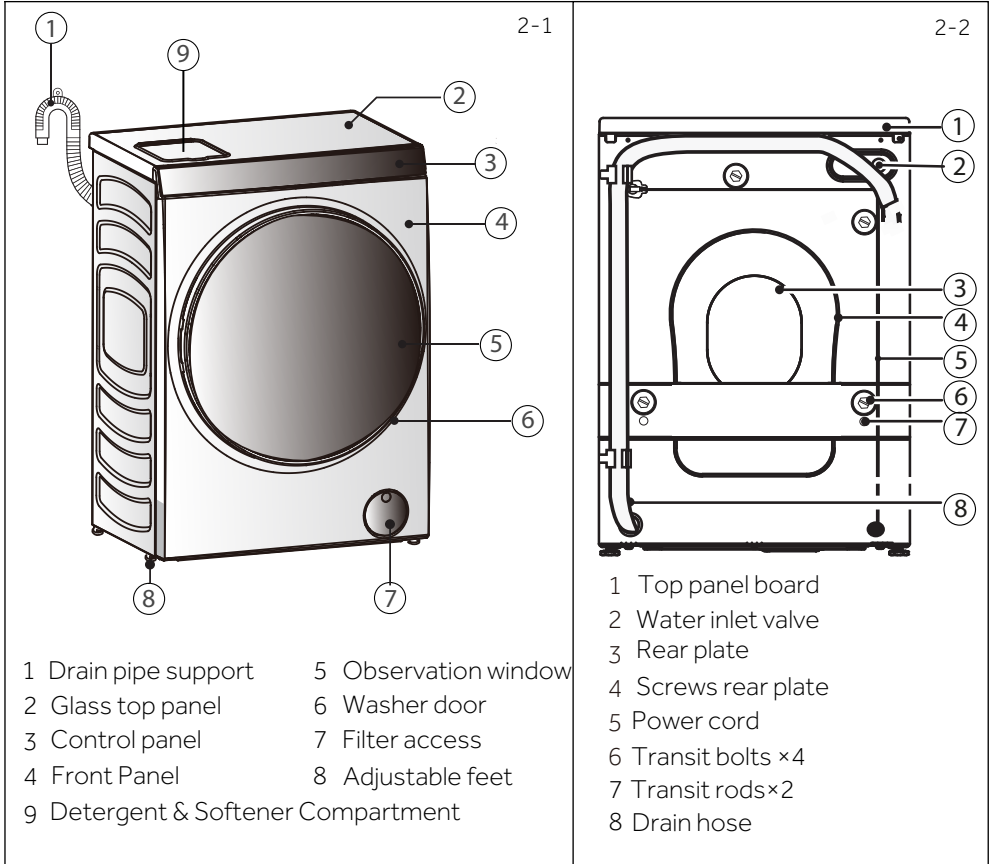

2.2 Accessories

Check the accessories and literature in accordance with this list (Fig. 2-3):

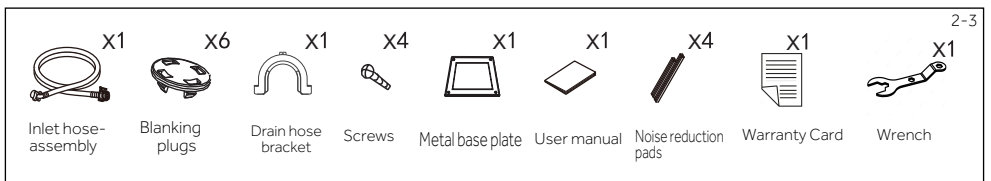

3.1 Unpacking

- ▶ Your washer is heavy. We recommend two people to remove the packaging.
 1. Remove the outer packaging including the polystyrene packer and plastic wrapping.
 2. Lift the washer off the base packaging, pick and put aside the accessories bag from top of the base packaging.
 3. Remove all packaging from the product.
 4. Dispose of all packaging sustainably, ensuring these materials are kept out of the reach of children.

3.2 OPTIONAL: Install noise reduction pads and metal board

1. When opening the shrink package, you will find four noise reduction pads. These are used for reducing noise (Fig. 3-1).
2. Lay the washing machine down to its side, porthole pointing upwards, bottom side towards operator.
3. Take out the noise reduction pads and remove the double-sided adhesive protective film; paste around the bottom; the noise reduction pads under the washing machine cabinet as shown in Figure 3 (two longer pads in position 1 and 3, two shorter pads in position 2 and 4). Finally set the machine upright again.
4. Tilt back the appliance (Fig 3-2).
5. Get the metal board from the top of the packaging foam and install to the bottom of the appliance, then fix the metal board with four screws (Fig 3-3).

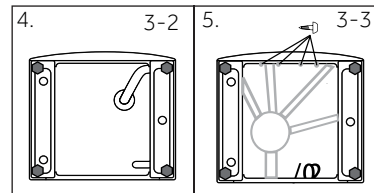
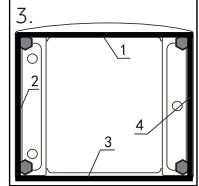
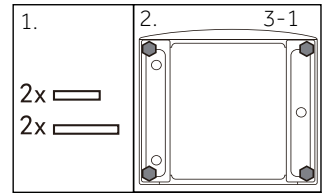

3.3 Dismantle the transportation bolts

The transportation bolts are designed for clamp in anti-vibration components inside the appliance during transportation to prevent inner damage.

1. Remove the 4 transportation bolts (A) on the rear side and take out plastic spacers (B) from inner side of the machine (Fig. 3-4 and Fig 3-5)
2. Remove two transit brace screws (C), then remove the brace (D) and remove the two transit rods (E) from the product (Fig 3-6).
3. Cover the transit bolt holes with plastic plugs (F) provided. Push the clip into place (Fig. 3-7).

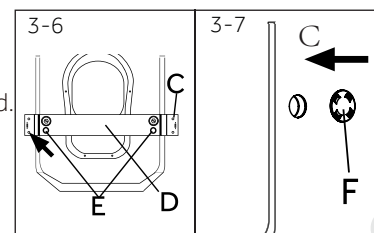
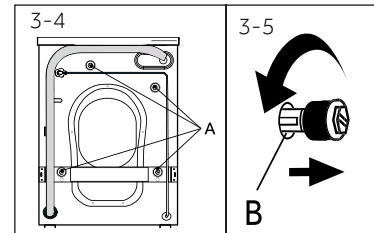



Note: Keep in safe place

- Keep all parts of the transport protection in a safe place for later use. Whenever the appliance is to be moved at first reinstall the protection parts.

3.4 Moving the appliance

If the machine is to be moved to a distant location, replace the transportation bolts removed before installation to prevent damage: The assembly takes place in reverse order.

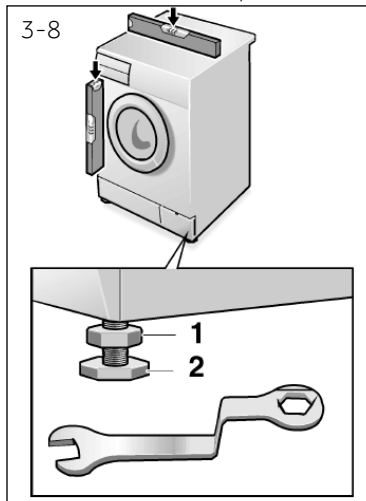

3.5 Leveling the appliance

Adjust all feet (Fig. 3-8) to achieve a complete level position. This will minimize vibrations and thus noise during use. It will also reduce wear and tear. We recommend to use a spirit level for adjustment. Floor should be as stable and flat as possible.

Level the washer side to side:

Place the level on the centre front of the washer. If you need to adjust the washer's position, loosen the lock nut using the spanner provided and turn the feet up or down until level. To wind the feet up turn clockwise, to wind the feet down turn counter-clockwise.

Level the washer front to back:

Place the level on the left side, in line with the centre of the washer. Adjust the front left foot and then the right foot until the washer is level.

There should be equal weight on both front feet.

Recheck the washer is level, front to back and side to side.

Repeat the above steps if required.

Using the spanner provided, tighten the lock nuts against the base of the washer to lock the feet in position.

Move and centre the washer back into its final position using adjacent walls as a guide.

3.6 Drain Hose Connection

Fix the water drain hose properly to the piping. The hose has to reach at one point a height between 80 and 100 cm above the appliance bottom line! If possible keep always drain hose fixed to the clip at the appliance back.

In multi-storey apartments or any upper floor, the washer should be installed on a floor equipped with a drain. Draining must comply with local by-laws.



WARNING!

- ▶ Use only the supplied hose set for the connection.
- ▶ Never reuse old hose sets!

Following connections are possible:

3.6.1 Drain hose to sink

- ▶ Hang the drain hose with the U-support over the edge of a sink with adequate size (Fig. 3-9).
- ▶ Protect the U-support sufficiently against slipping.

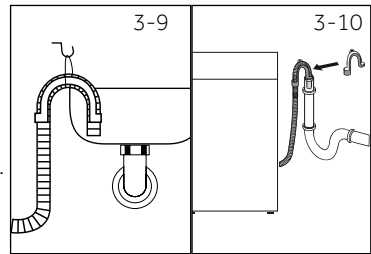

3.6.2 Drain hose to waste water connection

- ▶ The internal diameter of the stand pipe with vent-hole must be minimum 40 mm.
- ▶ Put the drain hose for 80-100mm in the wastewater pipe.
- ▶ Attach the U-support and secure it sufficiently (Fig. 3-10).

3.6.3 Drain hose to sink connection

- ▶ The junction must lie above the siphon.
- ▶ A spigot connection is usually closed by a pad (A). That must be removed to prevent any disfunction (Fig. 3-11).
- ▶ Secure the drain hose with a clamp.

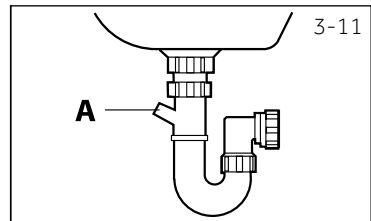

CAUTION!

- ▶ The drain hose should not be submerged in water and should be securely fixed and leak-free. If the drain hose is placed on the ground or if the pipe is at a height of less than 80 cm, the washing machine will continuously drain while being filled (self-siphoning).
- ▶ Drain hose is not to be extended. If necessary contact after sales service.

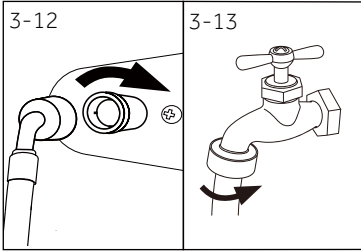

3.7 Connect to inlet hose

Make sure that the gaskets are inserted.

1. Connect the water inlet hose with the elbow end to the appliance (Fig. 3-12). Tighten the screw joint by hand.
2. The other end connect to a water tap with a 3/4" thread (Fig. 3-13)
3. Only connect to cold water supply, your washer has an internal heater to heat water.
Before connection, check the water is clear & clean.

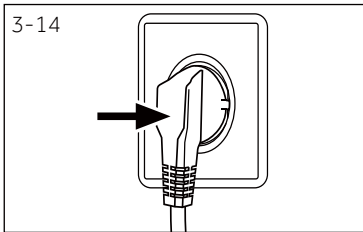

3.8 Electrical Connection

Before each connection check if:

- ▶ power supply, socket and fusing are appropriate to the rating plate.
- ▶ the power socket is earthed and no multi-plug or extension are used.
- ▶ the power plug and socket are strictly according.

Put the plug into the socket (Fig. 3-14).



WARNING!

- ▶ Ensure always that all connections (power supply, drain and fresh water hose) are firm, dry and leak free!
- ▶ Take care these parts are never to be crushed, kinked, or twisted.
- ▶ If the supply cord is damaged, it must be replaced by the service agent (see warranty card) in order to avoid a hazard.
- ▶ The appliance must not be supplied through an external switching device, such as a timer, or connected to a circuit that is regularly switched on and off by a utility.

3.9 Complete your installation

1. Press "Power button " to activate your washer.
 2. Select a Express15 cycle. Ensure the drum is empty and the door closed.
 3. Press "Start & pause" to start. The washer will start to fill.
 4. Wait until you see water in the bottom of the drum.
 5. Press "Start & pause" to stop the cycle, then press " Power button" to turn the washer off.
 6. Press "Power button " again, select the Rinse & Spin cycle and touch "Start & pause".
- Check the drain hose is firmly secured to the standpipe or tub, or spigot. Observe that the washer pumps out the water, and spins. The washer will beep to signal the end of the cycle. Any faults will be displayed on the screen, refer to Fault codes!

4.1 Additional technical data

	HWDX1590CTB1
Voltage in V	220-240 V~/50Hz
Current in A	10
Max. power in W	2100
Water pressure in MPa	$0.05 \leq P \leq 1$
Net weight in kg	110

4.2 Product dimensions

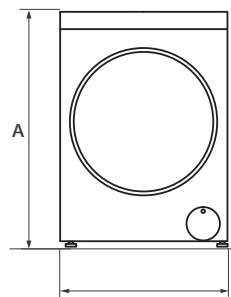

FRONT VIEW

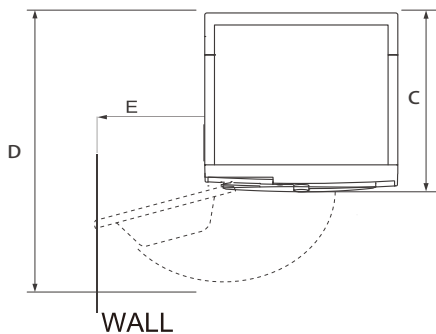

TOP VIEW

PRODUCT DIMENSIONS	HWDX1590CTB1
A Overall height of product mm	985
B Overall width of product mm	701
C Overall depth of product mm	688
D Depth of door open mm	1265
E Minimum door clearance mm	350

Note: The exact height of your washer is dependent on how far the feet are extended from the base of the machine. The space where you install your washer needs to be at least 40mm wider and 20mm deeper than its dimensions.

4.3 Cavity and clearance dimensions

Please take into account that this product requires top access to detergent compartment, for cavity installs please set the cavity height to allow adequate access to detergent compartment to help top up your cleaning agents.

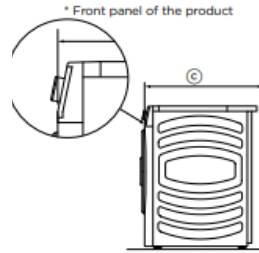
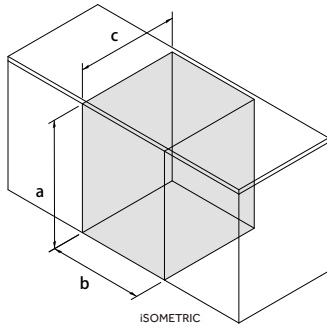

CAVITY DIMENSIONS		MM
A	Minimum cavity height (to clear the detergent compartment lid)	1200
B	Minimum cavity width	740
C	Minimum cavity depth	
	* Flush with front panel of the product*	620
	* In cupboard	655

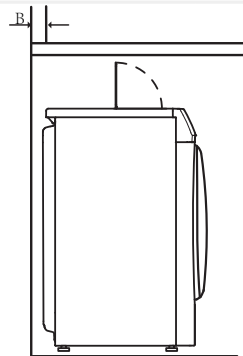
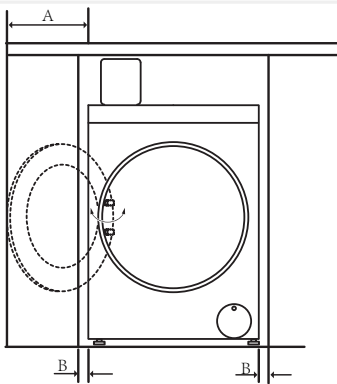

CLEARANCE DIMENSIONS		MM
A	Minimum washer door clearance to adjacent wall	350
B	Minimum gap clearance to adjacent product or cabinetry*	20

*Applies to sides, and rear

5-1

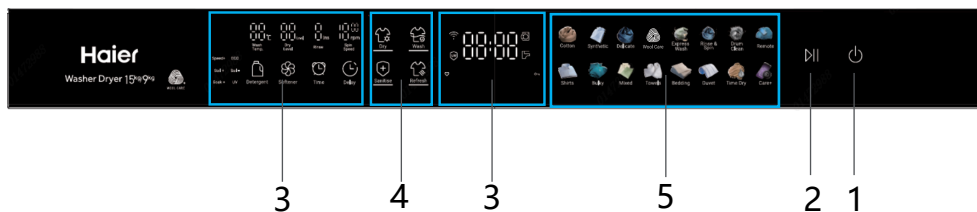

- 1 "Power" button
- 2 "Start/Pause" button
- 3 Display, Options & Settings
- 4 Function selection
- 5 Cycle selection



5.1 "Power" Button

Press the Power button (Fig.5-2) to turn ON and OFF the product. When power is on the display illuminates the default cycle and options; in dim light the displays shows possible modifiers and selectable options.

To provision the product for WiFi connection: Press and hold the Power button for five seconds until the "APP" is displayed on the screen. Follow the instructions in the App to get your appliance connected.



5.2 "Start/Pause" Button

Press the Start/Pause (Fig. 5-3) to start or interrupt the selected program.

5.3 Display ,Options&Settings

The display (Fig. 5-4) will show important information about cycle: Options and modifiers, remaining time, error codes and service information, warnings and notifications.

Options & Settings : Your appliance's cycles have specific default settings that have been designed to deliver good performance results. However, this appliance offers a series of buttons (Fig. 5-4)

that enable the cycle modifiers and additional selectable options for each cycle.

When a cycle is selected, the default options are fully lit on the display and the the other selectable options will appear dim in the display. If a modifier or selectable options has more than one possible value, toggle through the options by pressing the button sequentially until the preferred selection is illuminated or displayed on the screen.

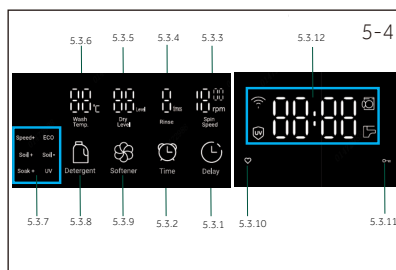

i Note: Factory settings

To get the best results in each programme, Haier has well defined specific default settings. If there is no special requirement, default settings are recommended.

Figure 5-1 shows the state of the machine when it is started

5.3.1 "Delay" Button

Set a delay time for the cycle to start. Avoid using this function (Fig. 5-5) for damp, non-colourfast items as this may cause dye run to occur.

The Delay function is available for all cycles.

Use "Delay" to select a desired time: 1 to 12 hours. 1 hour increments.

1 hour is the default time.

After pressing the Delay button, the Delay Icon LED will display

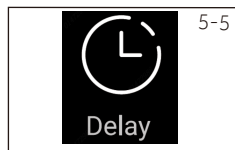

5.3.2 "Time" Button

Press "Time" to toggle through the options and select the desired Time Dry Time.(Fig.5-6)

The options are: 10, 20, 30, 40, 50, 60, 90, 120, 150, 180.

Default will be 10 mins.

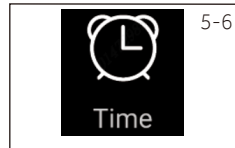

5.3.3 "Spin Speed" Button

The available Spin Speeds are: 0, 400, 800, 1000, 1200, 1300.

Press the Spin Speed button (Fig. 5-7) to change the spin at which the appliance will spin the clothes.

Lower spin speeds will leave the clothes wetter, which might increase the drying times.

Faster spin speeds might increase wrinkles in the clothes.

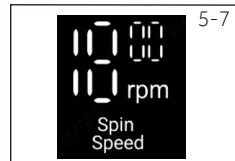

5.3.4 "Rinse" Button

Press "Rinse" to toggle and select the desired number of rinses for the wash cycle. At each level, the duration of rinse is multiplied accordingly. (Fig.5-8)

Additional rinses are recommended for people with sensitive skin to remove all detergent residue from the load

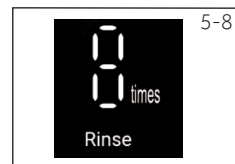

5.3.5 "Dry Level" Button

Press the Dry Level button (Fig. 5-9) to change the end dry level of the program.

L1: Damp/Dry - This setting is recommended for garments that will be finished with an iron treatment.

L2: Dry - This setting is recommended for the majority of garments; garments can be worn after drying.

L3: Extra Dry - Use this setting for large, bulky and durable items.

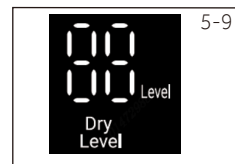

5.3.6 "Wash Temp" Button

Press "Wash Temp" to toggle and select the desired wash temperature.

If "--" is selected, the water will not be heated. (Fig.5-10)



5.3.7.1 "Speed + " Button

User "Speed +" to shorten the Wash time for small loads of lightly soiled items

When pressed the "Speed Up" Icon turns ON..(Fig.5-11)

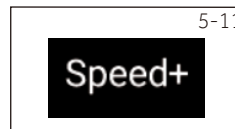

5.3.7.2 "Eco " Button

Use "ECO" (Fig. 3-12) to reduce energy consumption by setting a cold wash temperature, 1 rinse and 1200 spin speed.



5.3.7.3 "Soil + " Button

Use "Soil +" (Fig. 5-13) to modify the cycle settings to increase wash time and detergent for heavily soiled loads.



5.3.7.4 "Soil - " Button

Use "Soil -" (Fig. 5-14) to modify the cycle settings to decrease wash time and detergent for lightly soiled loads.



5.3.7.5 "Soak + " Button

Use "Soak+" to set a 60 minutes deep cleaning soak within the wash with intermittent agitation.(Fig.5-15)



5.3.7.6 "UV " Button

Use UV (Fig. 5-16) to turn ON and OFF the ultraviolet treatment during wash and rinses.

The use of UV sanitize will reduce germs and microorganisms in the water providing a cleaner and aseptic wash.

5.3.8 "Detergent" Button

Press to turn ON/OFF the Auto Dose Detergent for the desired cycle. (Fig.5-17).When Detergent level is low,the Detergent LED flashes and the machine Beeps. Sound turns OFF when user presses any key



The Auto Dose function dispenses the right amount of detergent for the clothes according to the weight and load type. The default setting is "L3", which is the average amount of detergent needed to launder a medium soiled load. There are 3 additional levels that allow to change the way the washer calculates the volume of liquid detergent; this enables a personalized experience according to the laundry needs. For lightly soiled clothes, use level "L1" or level "L2" and for heavily soiled clothes we recommend setting the washer to level "L4". Similarly, for sensitive skin, we recommend using the lower setting "L1", to minimize possible residual detergent in the clothes. Press the "Detergent" button for 3 sec. The machine beeps once and the Detergent LED flashes.



To set up detergent level:

Press the "Detergent" button to toggle through the dosage options. With the preferred option selected on the 7-Seg, the setting is saved through inactivity of 3 sec, or by pressing any other button.

The machine beeps once and the Detergent LED stays ON.

5.3.9 "Softener " Button

Press to turn ON/OFF Auto Dose Softener for the desired cycle. (Fig.5-18) When Softener level is low, the Softener LED flashes and the machine beeps.



5.3.10 "Favourite" ♥ Button

Use "Favourite" to save personalised options for available cycles. (Fig.5-19) Select the desired cycle & settings. Press the favorite button - the heart icon for 3 seconds. The LED flashes 3 times and the machine beeps. Then the "heart" LED stays illuminated indicating that the favorites configuration has been saved.



5.3.11 "Key lock" Button

Use "Keylock" to disable all buttons and dial, except for the "Power" button. (Fig.5-20)

To turn ON press the keylock button for 3 sec - The machine beeps once and the lock LED turns ON.

To turn OFF press the same button combination for 3 sec - The machine beeps once and the lock LED turns OFF.

Keylock is able to be activated at anytime power is on
 If a button is pressed while the "Keylock" is ON, the lock LED flashes 3 times , machine beeps and displays CLOI- to communicate the status.

Once active, there is no means to start or restart a cycle without deactivation of Keylock .



Keylock would remain active after blackout/brownout.

5.3.12 Display icon description



This icon is displayed when the washing machine is connected to the Wi-Fi network.



When the washing machine door is not closed, this icon is displayed.



This icon lights up when the UV light is turned ON.



This icon will light up if there is no water supply to the product.

5.4 Function buttons

Your appliance has four primary functions: Wash, Dry, Refresh & Sanitise. Touch the button to choose among various treatment options for your garments.

The symbols are explained as follow:

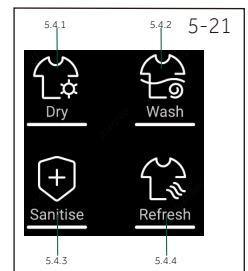

5-Control panel

NZ AU

5.4.1 "Dry " Button

Press "Dry" to select this primary function. (Fig.5-22)

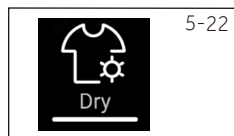

5.4.2 "Wash" Button

Press "Wash" to select this primary function. (Fig.5-23)



5.4.3 "Sanitise" Button

Press "Sanitise" to select this primary function.(Fig.5-24)

High heat continuous wash & dry cycles designed for sanitizing a variety of durable fabrics.Available for cycles : Cotton, Shirts, Bulky, Mixed, Towels, Bedding, Duvet, Care+. Please see wash cycles table (page 22) for recommended settings.



5.4.4 "Refresh" Button

Press "Refresh" to select this primary function(Fig.5-25)

Quick steam cycles designed for refreshing dry garments.Available cycles: Cotton, Synthetic, Delicate, WoolCare, Shirts, Bulky. For better results, its is recommended to treat one garment at a time. Hang garments as soon as the cycle is complete to reduce the need for ironing.

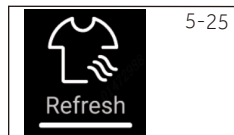

5.4.5 "Wash & Dry" Button

Press Wash and Dry icons to select this function. Both icons lit on to indicate the function is activated.

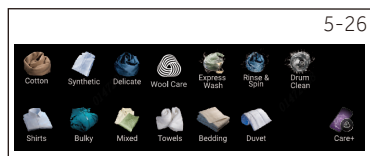

5.5 Cycle selection

The cycle selection area displays the available cycles for the chosen function. Wash (Fig. 5-26), Dry (Fig. 5-27), Sanitise(Fig. 5-28), Refresh (Fig. 5-29), Wash & Dry (5-30)

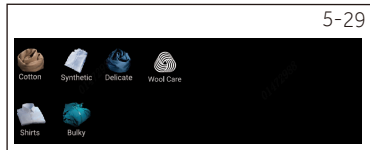

Your appliance can be connected to your home wireless network and operated remotely using the app.

Getting started

Ensure your home Wi-Fi network is turned on.

You will be given step by step guidance on both your appliance and mobile device.

It may take up to 10 minutes to connect your appliance.

On your mobile device:

1. Your product is Wi-Fi connectable. Please visit the webpage below to download the app and find out more:
Australia <https://www.haier.com.au/smart>
New Zealand <https://www.haier.co.nz/smart>
2. Register and create an account.
3. Add your appliance and set up the Wi-Fi connection

Connect to your home Wi-Fi

To provision the product for Wi-Fi connection: Press and hold the Power button for five seconds until the "APP" is displayed on the screen. Follow the instructions in the App to get your appliance connected.

When your machine is connected to Wi-Fi successfully, the icon  lights up.

Remote Mode

Press and hold Remote button for 3 seconds to turn ON and Off the Remote Mode function.

When the Remote Mode is ON the appliance can be controlled by the Smart HQ App for your convenience.

Not all functions will be available through the App.

During Remote operation, the washer door will be locked. At the end of the cycle, the Remote Mode will be automatically turned OFF to release the door lock.

Wash cycles

• Yes, ◦ Optional, / No

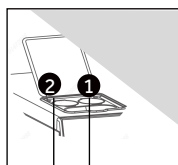

Detergent compartment for:

- 1 Softener or care product
- 2 Liquid Detergent¹⁾

Cycles	Max. load washing in kg	Temperature in °C ²⁾	Preset	Designed for		Preset spin speed in rpm	Function		
				2	1		Smart Dose	Wash Temp.	UV
Cotton	15	* to 90	*	•	•	1300	•	•	•
Synthetic	15	* to 60	30	•	•	1200	•	•	•
Delicate	1	* to 30	30	•	•	800	•	•	•
Wool Care	1	* to 30	*	•	•	800	•	•	•
Express wash	2	/	/	•	•	800	•	/	/
Rinse & Spin	15	/	/	/	/	1000	/	/	/
Drum Clean	/	/	/	/	/	/	/	/	/
Shirts	4	* to 90	30	•	•	1000	•	•	•
Bulky	7	* to 90	30	•	•	1300	•	•	•
Mixed	15	* to 90	*	•	•	1300	•	•	•
Towels	7	* to 90	60	•	•	1300	•	•	•
Bedding	7	* to 90	60	•	•	1300	•	•	•
Duvet	1 item	* to 90	60	•	/	800	•	•	•
Care+	Single piece	* to 90	60	•	•	1300	•	•	•

* Water is not heated up.

1) Liquid Detergent only be used for smart dose.

2) Choose 90°C wash temperature only for special hygienic requirements.

3) For Express wash cycle, detergent amount is reduced since the programme duration is short.

The design and specifications are subject to change without notice for quality improvement purposes.

Washer Registration Cycle

The warm wash performance cycle (Cotton, 40°C, Rinse: 2 times, 1400 rpm, Detergent: Off, Softener: Off) is the recommended cycle for a normally soiled load equal to the rated load capacity (15kg).

Standard programme for the Energy and Water Labelling according to AS/NZS 2040.2. Select mode Wash, Cotton, 40°C, rinsed 2 times, 1400 RPM, cancel the auto dose of detergent and softener.

After the weighing is complete, water is started, 70% of the detergent dry powder is put into the dispenser box, then quickly pour the pbis and themaximum amount of foam inhibitor.

Detergent dissolvent method: Dissolve the detergent first and pour the dissolved detergent into the machine when the main wash starts. The washing operation starts at the end of the first water filling.

Dry Cycles

Cycles	Default dry level	Designed for	Max. load drying, in kg
Cotton	L-2	Autosensing cycle for garments made of cotton fabrics.	9
Mixed	L-2	Autosensing cycle for loads with different types of clothes and fabrics.	9
Synthetic	L-2	Autosensing cycle for garments made with synthetic fabrics or synthetic blends.	9
Delicate	L-2	Gentle autosensing cycle for delicate garments.	1
Shirts	L-2	Suitable for conventional drying of cotton, linen and poly-cotton blended shirts.	4
Bulky	L-2	It is suitable for drying large clothes of heat-resistant cotton and linen and their mixed materials.	5.5
Towels	L-2	Autosensing cycle designed to dry thick, durable and absorbent items such as towels.	5.5
Bedding	L-2	Autosensing cycle with a reverse pattern designed to dry bed sheets.	5
Duvet	L-2	Autosensing cycle with a reverse pattern designed to dry duvet & quilts..	1 item
Time Dry	/	Timed cycle that uses hot air to dry garments.	/
Care +	L-2	Suitable for drying denim clothes.	3

*THE DRY LEVEL OPTIONS ARE L3: Extra dry, L2: Dry (default) and L1:Damp

Dryer Registration Cycle

Cotton, Dry, Dry Level: L3 is the recommended energy saving cycle for everyday drying.

Check the energy label for energy consumption information.

The actual energy consumption may differ from the declared one according to local conditions.

Actual water temperature may differ from declared cycle temperature.

**Note: Auto Weight**

The appliance is equipped with a loading recognition. At low loading, energy, water and washing time will be reduced automatically in some programmes. The display shows "AU t0".

Woolmark Wool Care

The wool wash cycle of this machine has been tested and approved by The Woolmark Company for the washing of machine washable wool products provided that the products are washed according to the instructions on the garment label and those issued by the manufacturer of this washing machine.M2405.



WOOL CARE

8.1. Power supply

Connect the washing machine to a power supply (220V to 240V~/50Hz; Fig.8-1). Please refer also to section Installation.

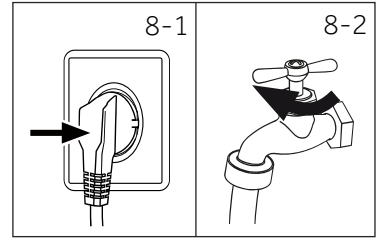

8.2. Water connection

- ▶ Before connecting check the cleanliness and clarity of the water inlet.
- ▶ Turn on the tap (Fig.8-2).



Note: Tightness

Before use check for leakage in the joints between the tap and the inlet hose by turning on the tap.

8.3. Preparing laundry

- ▶ Sort out clothes according to fabric (cotton, synthetics, wool or silk etc.) and how dirty they are (Fig.8-3). Pay attention to the care labelling of washing labels.
- ▶ Separate white clothes from coloured ones. Wash coloured textiles first by hand to check if they fade or run.
- ▶ Empty pockets (keys, coins, etc.) and remove harder decorative objects (e.g. brooches) as well as flammable objects (paper tissues, lighters, matches etc.).
- ▶ Garments without hems, delicates and finely woven textile such as fine curtains are to be put into a wash bag to care for this delicate laundry (hand or dry cleaning would be better).
- ▶ Close zippers, velcro fastener and hooks, make sure the buttons are sewn on tightly.
- ▶ Place sensitive items like laundry without firm hem, delicate underwear (Dessous) and small items such as socks, belts, bras, etc. in a wash bag.
- ▶ Unfold large pieces of fabric such as bed sheets, bedspreads etc.
- ▶ Turn jeans and printed, decorated or color-intensive textiles inside out; possibly wash separately.

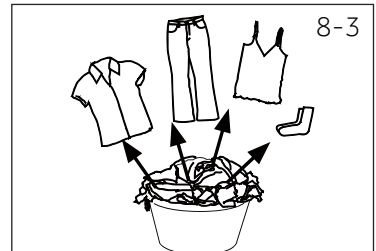

Note: Special hints for drying

- ▶ Sort clothes according to fabric (cotton, synthetics, etc.) desired dry level and equal residual moisture. Follow the instructions on the laundry label and dry only machine dryable garments
- ▶ Spin the laundry with the maximum spin speed before drying.
- ▶ Do not exceed the max. load.
- ▶ Extra large pieces tend to wind up. If the laundry has not been sufficiently dry, loosen up the laundry and dry again with programme Dry .
- ▶ Especially delicate fabrics which can easily shrink or lose their shape, as well as e.g. silk stockings, lingerie etc. should not be dried with the appliance. Put delicate garments inside a laundry bag and avoid overdrying them.
- ▶ Jersey and knitwear should not be dried to avoid shrinkage.

Care chart

Washing			
 Washable up to 90°C normal process	 Washable up to 60°C normal process	 Washable up to 60°C mild process	
 Washable up to 40°C normal process	 Washable up to 40°C mild process	 Washable up to 40°C very mild process	
 Washable up to 30°C normal process	 Washable up to 30°C mild process	 Washable up to 30°C very mild process	
 Wash by hand max. 40°C	 Do not wash		
Bleaching			
 Any bleaching allowed	 Only oxygen/ non-chlorine	 Do not bleach	
Drying			
 Tumble drying possible normal temperature	 Tumble drying possible lower temperature	 Do not tumble dry	
 Line drying	 Flat drying		
Ironing			
 Iron at a maximum temperature up to 200°C	 Iron at a medial temperature up to 150°C	 Iron at a low temperature up to 110°C; without steam (steam ironing may cause irreversible damage)	
 Do not iron			
Professional Textile Care			
 Dry cleaning in tetrachloroethene	 Dry cleaning in hydrocarbons	 Do not dry clean	
 Professional wet clean	 Do not professional wet clean		

8.4 Loading the appliance

- ▶ Put in the laundry piece by piece.
- ▶ Don't overload. Note the different maximum load according to programmes! Rule of thumb for maximum load: Keep six inches between load and drum top.
- ▶ Close the door carefully. Make sure that no pieces of laundry are pinched.



CAUTION!

Non-textile, as well as small, loose or sharp-edged items may cause malfunctions and damage of clothes and appliance.

8.5 Selecting detergent

- ▶ Washing efficiency and performance is determined by used detergent quality.
- ▶ Use only machine wash approved detergent.
- ▶ If needed use specific detergents, e.g for synthetic and woolen fabric.
- ▶ See tips for countertop detergent stickers.
- ▶ Do not use dry cleaning agents such as trichloroethylene and similar products.
- ▶ Detergent type should meet the requirements of local users.

Choose the best detergent

Programme	Kind of detergent				
	Universal	Colour	Delicate	Special	Softener
Cotton	o	o	-	-	o
Synthetics	-	o	-	-	o
Delicate	-	-	o	o	o
Bulky	P	o	-	-	o
Shirts	o	o	-	-	o
Drum Clean	-	-	-	o	-
Express Wash	L	L	-	-	o
Wool Care	-	-	o	o	o
Rinse & Spin	-	-	-	-	o
Bedding	o	o	-	-	o
Towels	-	L	-	-	o
Care +	-	L	-	o	o
Duvet	L	o	-	-	-
Mixed	L	o	-	-	o

L = gel-/liquid detergent P = powder detergent O = optional - = no
 If using liquid detergent, it is not recommended to activate the time delay.

We recommend by using:

- ▶ Laundry powder: 20°C to 90°C* (best use: 40-60°C)
- ▶ Color detergent: 20°C to 60°C (best use: 30-60°C)
- ▶ Wool/delicate detergent: 20°C to 30°C (best use: 20-30°C)

* Choose 90 °C wash temperature only for special hygienic requirements.

* If you choose the water temperature 60°C or above, we would like to advise you to use less detergent. Please kindly use the special disinfectant, which is suitable for cotton or synthetic cloth.

* It is better to use less or free suds detergent powder.

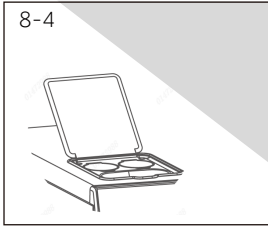

8.6 Add detergent

1. Open the lid of detergent compartment.
2. Put the required chemicals into corresponding compartments (Fig. 8-4),
3. Close all the lids.

i Note:

- ▶ Wipe clean any detergent & softener residues from dispenser cover.
- ▶ Do not overuse detergent or softener.
- ▶ Please follow the instruction on the detergent package.
- ▶ Always fill the detergent just before the beginning of the wash cycle.
- ▶ Concentrated liquid detergent should be diluted before adding.
- ▶ Carefully choose the programme settings according to the care symbols on all laundry labels and according to the programme table.
- ▶ The detergent compartment with large opening (no lids) is for manual dispensing only, either a powder or liquid detergent could be used.



8.7 Switch on the appliance

Touch the "Power" button to switch on the appliance (Fig.8-5). The LED of the "Start/Pause" button is flashing.



8.8 Select a function

Select the desired treatment method for your garment by simply pressing on the icons(Fig.8.6).

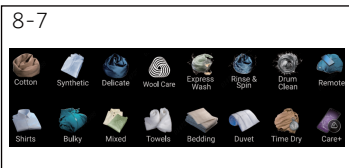

8.9 Select a cycle

Select the appropriate cycle that suits with your laundry items by simply pressing on the icon(Fig.8.7),

i Note: Before first wash

It is recommended before using the product to run a Cotton cycle with 90° C wash temp and 600 rpm spin speed without any load to reduce odors.

8.9 Add individual selections

Select required options and settings (Fig. 8-8); refer to Control Panel.

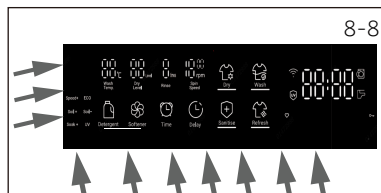

8.10 Start the cycle

Press "Start/Pause" button (Fig. 8-9) to start. The LED stops flashing and lights up continuously.

Appliance operates according to present settings.

Changes are only possible by cancelling the programme.



8.11 Interrupt / cancel cycle

To interrupt a running programme press gently "Start/Pause". The LED above the button is flashing. Press it again to resume operation.

To cancel a running programme and all its individual settings:

1. Press "Start/Pause" button to interrupt the running programme.
2. Touch "Power" button for about 2 seconds to switch the appliance off.



Note: Door lock

- ▶ For safety reasons the door is locked partially during the washing cycle. It is only possible to open the door at the end of the programme or after the programme was cancelled correctly (see description above).
- ▶ In case of high water level, high water temperature and during spinning it is not possible to open the door; **Loc L** is displayed.
- ▶ For safety reasons door might be locked during drying cycles depending on the temperatures inside the drum, **LOCK** is displayed. If the cycle is interrupted, please allow time for cool down and the door will unlock automatically."

8.12 After washing

1. At programme cycle end **End** is displayed.
2. The appliance switches off automatically.
3. Remove laundry as soon as possible to avoid wrinkling.
4. Turn off the water supply.
5. Unplug the power cord.
6. Open the door to prevent formation of moisture and odours. leave it open while not used.



Note: Standby-mode

To save energy the product will enter standby-mode and the display will turn off after 2 minutes of inactivity.



Note: Information Note

Drying cycles conclude with a cooling down period to ensure your garments are at safe temperatures to handle.



Environmentally responsible use

Washing

- ▶ To achieve best use of energy, water, detergent and time you should use the recommended maximum load size.
- ▶ Do not overload (hand width clearance above laundry).
- ▶ For slightly soiled laundry select the Express wash programme.
- ▶ Apply exact dosages of each washing agent.
- ▶ Choose the lowest adequate washing temperature - modern detergents are efficiently cleaning below 60°C.
- ▶ Raise default settings only due to heavy staining.
- ▶ Spin the laundry with the maximum spin speed if you want to use a drying programme afterwards.

Drying

- ▶ Use the maximum filling amount of about 8/9 kg
- ▶ Loosen up the laundry before starting the drying programme.

10.1 Cleaning the detergent compartment

Take always care there are no detergent residues. Clean it regularly (Fig. 10-1):

1. Open all the lids
2. Wipe clean any detergent & softener residues from dispenser cover.
3. Close the lids, don't leave them open.

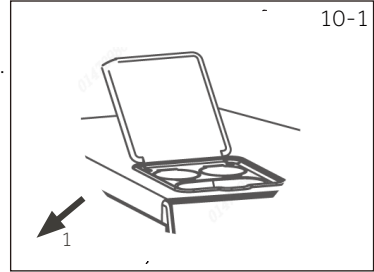

10.2 Cleaning the machine

- ▶ Unplug the machine during cleaning and maintenance.
- ▶ Use a soft cloth with soap liquid to clean the machine case (Fig. 10-2) and rubber components.
- ▶ Do not use organic chemicals or corrosive solvents



10.3 Water inlet valve and inlet valve filter

To prevent blockage of water supply by solid substances like lime clean regularly the inlet valve filter.

- ▶ Unplug the power cord and turn off the water supply.
- ▶ Unscrew the water inlet hose at the back (Fig. 10-3) of the appliance as well as on the tap.
- ▶ Flush the filters with water and a brush (Fig. 10-4).
- ▶ Insert the filter and install the inlet hose.

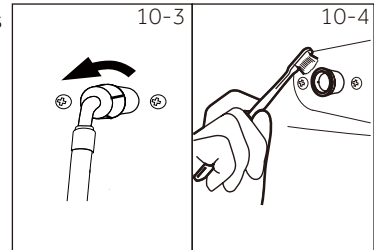

10.4 Cleaning the drum

- ▶ Remove accidentally washed items, especially metal parts such as pins, coins, etc. from the drum (Fig. 10-5) because they cause rust stains and damage.
- ▶ Use a non-chloride cleaner for removing rust stains. Observe the warning hints of the cleaning agent manufacturer.
- ▶ Do not use any hard objects or steel wool for cleaning.

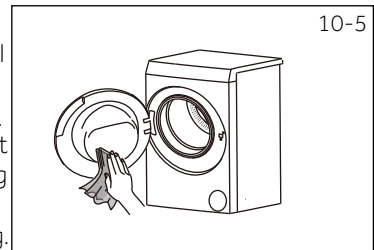

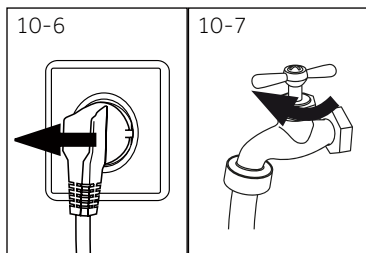

10.5 Long periods of disuse

If the appliance is left idle for a longer period:

1. Pull out the electrical plug (Fig. 10-6).
2. Turn off water supply (Fig. 10-7).
3. Open the door to prevent formation of moisture and odours. Let door open while not used.

Before next usage check carefully power cord, water inlet and drain hose. Make sure everything is properly installed and without leakage.

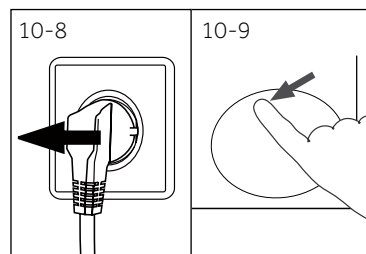

10.6 Pump filter

Clean the filter once a month and check the pump filter for instance if the appliance:

- ▶ Doesn't drain the water.
- ▶ Doesn't spin.
- ▶ Cause unusual noise while running.



WARNING!

Scalding Risk! Water in the pump filter can be very hot! Before any action please ensure water has cooled down.

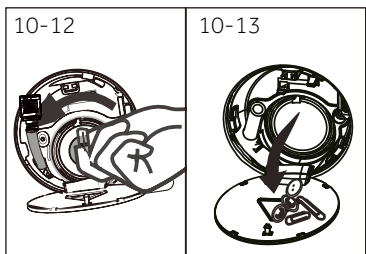
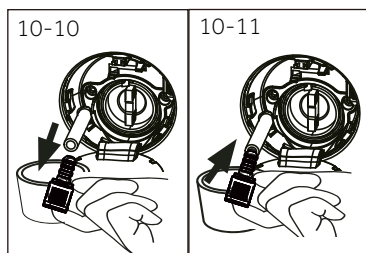

1. Turn off and unplug the machine (Fig. 10.8).
2. Push and open service flap (Fig. 10-9).
3. Provide a flat container to catch leach water (Fig. 10-10) There could be bigger amounts!
4. Pull the drainhose out and hold its end above the container (Fig. 10-10).
5. Take the sealing plug out of the drainhose (Fig. 10-10).
6. After complete drainage close drainhose (Fig. 10-11) and push it back into the machine.
7. Unscrew and remove counter clockwise the pump filter (Fig. 10-12).
8. Remove contaminants and dirt (Fig. 10-13).

9. Clean carefully pump filter, e.g. using running water (Fig. 10-14).
10. Refix it thoroughly (Fig.10-15).
11. Close service flap.

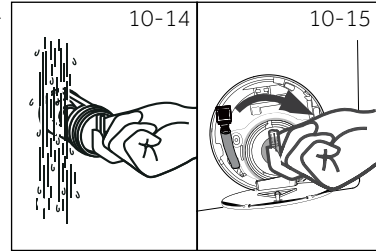

CAUTION!

- ▶ Pump filter sealing has to be clean and unhurt. If the lid is not full tightened, water can escape.
- ▶ The filter must be in place, or it may lead to leakage.
- ▶ Oil-affected items can ignite spontaneously, especially when exposed to heat sources, such as in a tumble dryer. The items become warm, causing an oxidation reaction in the oil. Oxidation creates heat. If the heat cannot escape, the items can become hot enough to catch fire. Piling, stacking or storing oil-affected items can prevent heat from escaping and so create a fire hazard.

If it is unavoidable that fabrics that contain vegetable or cooking oil or have been contaminated by hair care products be placed in a tumble dryer they should first be washed in hot water with extra detergent - this will reduce, but not eliminate, the hazard.

Many occurring problems could be solved by yourself without specific expertise. In case of a problem please check all shown possibilities and follow below instructions before you contact an after sales service. See CUSTOMER SERVICE.



WARNING!

- ▶ Before maintenance, deactivate the appliance and disconnect the mains plug from the mains socket.
- ▶ Electrical equipment should be serviced only by qualified electrical experts, because improper repairs can cause considerable consequential damages.
- ▶ A damaged power cable should only be replaced by the manufacturer, its service agent or similarly qualified persons in order to avoid a hazard.

11.1 Information codes

Following codes are displayed only for information referring to the washing cycle. No measures must be performed.

Code	Message
01:25	The remaining wash cycle time will be 1 hour and 25 minutes.
06:30	The remaining wash cycle time including chosen end-time delay will be 6 hours and 30 minutes.
AUTO	Automatic
End	The washing cycle is finished. The appliance shuts off automatically.
CLD L	Function keylock is activated.
Loc L	Door is closed because of high water level, high water temperature or spinning cycle.
bEEP OFF	The buzzer is deactivated.
bEEP ON	The buzzer is activated.

11.2 Troubleshooting with display code

Problem	Cause	Solution
CLr FLtr	<ul style="list-style-type: none"> • Drainage error, water is not fully drained within 6 minutes. 	<ul style="list-style-type: none"> • Clean pump filter. • Check drain hose installation.
door	<ul style="list-style-type: none"> • Lock error. 	<ul style="list-style-type: none"> • Shut the door properly.
E4	<ul style="list-style-type: none"> • Water level not reached after 8 minutes. • Drain hose is self-syphoning. 	<ul style="list-style-type: none"> • Make sure that tap is fully opened and water pressure is normal. • Check drain hose installation.
EB	<ul style="list-style-type: none"> • Water protective level error. 	<ul style="list-style-type: none"> • Contact the After sales service.

Problem	Cause	Solution
F3	<ul style="list-style-type: none"> Temperature sensor error. 	<ul style="list-style-type: none"> Contact the After sales service.
F4	<ul style="list-style-type: none"> Heating error. 	<ul style="list-style-type: none"> Contact the After sales service.
F7	<ul style="list-style-type: none"> Motor error. 	<ul style="list-style-type: none"> Contact the After sales service.
F9	<ul style="list-style-type: none"> Dry temperature sensor error. 	<ul style="list-style-type: none"> Contact the After sales service.
F8	<ul style="list-style-type: none"> Water level sensor error. 	<ul style="list-style-type: none"> Contact the After sales service.
EE1 or EE2 EE3	<ul style="list-style-type: none"> Abnormal communication error. 	<ul style="list-style-type: none"> Contact the After sales service.
Fd	<ul style="list-style-type: none"> Dry heating element error. 	<ul style="list-style-type: none"> Contact the After sales service.
FE	<ul style="list-style-type: none"> Dry motor error. 	<ul style="list-style-type: none"> Contact the After sales service.
E12	<ul style="list-style-type: none"> Drying water level is too high. 	<ul style="list-style-type: none"> Contact the After sales service.
E2	<ul style="list-style-type: none"> Door lock abnormal. 	<ul style="list-style-type: none"> Contact the After sales service.

11.3 Troubleshooting without display code

Problem	Cause	Solution
Appliance fails to operate.	<ul style="list-style-type: none"> Programme is not yet started. Door is not properly closed. Machine has not been switched on. Power failure. Child lock is activated. 	<ul style="list-style-type: none"> Check programme and start it. Close the door properly. Switch the machine on. Check power supply. Deactivate child lock.
Appliance will not be filled with water.	<ul style="list-style-type: none"> No water. Inlet hose is kinked. Inlet hose filter is blocked. Water pressure is less than 0.05 MPa. Door is not properly closed. Water supply failure. 	<ul style="list-style-type: none"> Check water tap. Check inlet hose. Unblock inlet hose filter. Check water pressure. Close the door properly. Ensure the water supply.
Appliance is draining while being filled.	<ul style="list-style-type: none"> Height of drain hose is below 80 cm. Drain hose end could reach into water. 	<ul style="list-style-type: none"> Make sure that drain hose is properly installed. Make sure the drain hose is not in water.
Drainage failure.	<ul style="list-style-type: none"> Drain hose is blocked. Pump filter is blocked. Drain hose end is higher than 100 cm above floor level. 	<ul style="list-style-type: none"> Unblock drain hose. Clean pump filter. Make sure that drain hose is properly installed.

Problem	Cause	Solution
Strong vibration while spinning.	<ul style="list-style-type: none"> • Not all transportation bolts have been removed. • Appliance has no solid position. • Machine load is not correct. 	<ul style="list-style-type: none"> • Remove all transportation bolts. • Ensure solid ground and a levelled position. • Check load weight and balance.
Operation stops before completing wash cycle.	<ul style="list-style-type: none"> • Water or electric failure. 	<ul style="list-style-type: none"> • Check power and water supply.
Operation stops for a period of time.	<ul style="list-style-type: none"> • Appliance displays error code. • Problem due to load pattern. • Programme performs soaking cycle. 	<ul style="list-style-type: none"> • Consider display codes. • Reduce or adjust load. • Cancel programme and restart.
Excessive foam floats drum and/or detergent drawer.	<ul style="list-style-type: none"> • Detergent is not appropriate. • Excessive use of detergent. 	<ul style="list-style-type: none"> • Check detergent recommendations. • Reduce amount of detergent.
Automatic adjustment of washing time.	<ul style="list-style-type: none"> • Washing programme duration will be adjusted. 	<ul style="list-style-type: none"> • This is normal and doesn't affect functionality.
Spinning fails.	<ul style="list-style-type: none"> • Unbalance of laundry. 	<ul style="list-style-type: none"> • Check machine load and laundry and run a spinning programme again.
Unsatisfactory washing result	<ul style="list-style-type: none"> • Degree of pollution does not agree with selected programme. • Detergent quantity was not sufficient. • Maximum load has been exceeded. • Laundry was unevenly distributed in the drum. 	<ul style="list-style-type: none"> • Select an other programme. • Choose the detergent according to the degree of pollution and the manufacturer specifications. • Reduce loading. • Loosen the laundry.
Washing powder residues are on the laundry.	<ul style="list-style-type: none"> • Insoluble particles of detergent can remain as white spots on the laundry. 	<ul style="list-style-type: none"> • Perform extra rinse. • Try to brush the points from the dry laundry. • Choose an other detergent.
Laundry has grey patches.	<ul style="list-style-type: none"> • Caused by fats such as oils, creams or ointments. 	<ul style="list-style-type: none"> • Pretreat the laundry with a special cleaner.

11.4 In case of emergency

In an emergency (such as a power failure), you can manually open the door lock to remove your load. If the water level of the lower drum wash machine is higher than the opening of the door, first drain the water from the bucket. See the process described in "Pump filter". Open the drain filter door (Fig.12-1) and pull the lever until the door is unlocked with a gentle click. When power is restored operation will resume

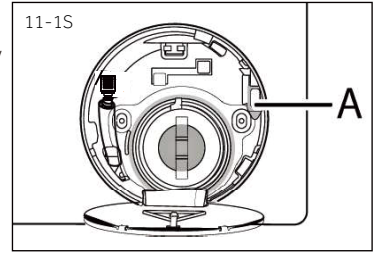

When the washing machine in a safe state (under the water level below the window along a certain distance, barrel temperature below 55°C, the inner barrel did not turn), may unlock the doors of the machine operation.

We recommend our Haier Customer Service and the use of original spare parts.
If you have a problem with your appliance, please first check section TROUBLESHOOTING.

If you cannot find a solution there, please contact:

- ▶ your local dealer.
- ▶ the Service & Support area at www.haier.com where you can find telephone numbers and FAQs and where you can activate the service claim.

To contact our Service, ensure that you have the following data available.
The information can be found on the rating plate.

Model _____ Serial No. _____

Also check the Warranty Card supplied with the product in case of warranty.

For general business enquiries please contact our Customer Care Centre according to Warranty Card.

For more information please refer to www.haier.com.



Haier

0020511111