



USER GUIDE
HEAT PUMP CLOTHES DRYER

HDHP80AN1
HDHP80ANB1

NZ AU

Haier

Thank you for purchasing a Haier Product.

Please read these instructions carefully before using this appliance. The instructions contain important information which will help you get the best out of the appliance and ensure safe and proper installation, use and maintenance.

Keep this manual in a convenient place so you can always refer to it for the safe and proper use of the appliance.

If you sell the appliance, give it away, or leave it behind when you move house, make sure you also pass this manual so that the new owner can become familiar with the appliance and safety warnings.

Legend



Warning! – Important safety information



General information and tips



Environmental information

Disposal



Help protect the environment and human health. Put the packaging in applicable containers to recycle it. Help to recycle waste of electrical and electronic appliances. Do not dispose appliances marked with this symbol with the household waste. Return the product to your local recycling facility or contact your municipal office.



WARNING!

Risk of injury or suffocation!

Disconnect the appliance from the mains supply. Cut off the mains cable and dispose of it. Remove the door catch to prevent children and pets to get closed in the appliance.



WARNING!

The appliance must not be supplied through an external switching device, such as a timer, or connected to a circuit that is regularly switched on and off by a utility.

Safety information	4
Intended use.....	7
Product description.....	8
Control panel.....	9
WiFi connection & Remote mode.....	12
Dry cycles.....	13
Dry Preparation.....	14
Getting started quickly.....	16
Care and cleaning.....	18
Before you call for service.....	21
Fault codes.....	22
Troubleshooting.....	23
Installation	26
Manufacturer's warranty.....	29
Customer care	31



WARNING!

Before use

- ~ Make sure there is no transport damage.
- ~ Remove all packaging and keep out of children.
- ~ Handle the appliance always with at least two persons because it is heavy.

Daily use

- ~ This appliance can be used by children aged from 8 years and above and persons with reduced physical, sensory or mental capabilities or lack of experience and knowledge if they have been given supervision or instruction concerning use of the appliance in a safe way and understand the hazards involved.
- ~ Keep away children under 3 years of age from the appliance unless they are constantly supervised.
- ~ Children shall not play with the appliance.
- ~ Do make sure the room is dry and well ventilated. The ambient temperature should be between 5 °C and 35 °C.
- ~ Do not cover any ventilation openings in the base by a carpet or similar object.
- ~ Keep the area around the tumble dryer free of dust and lint.
- ~ Do make sure that there is only laundry inside the appliance and no pets or children before you use it.
- ~ Only touch the mains plug with dry hands and do not touch or use the appliance if you are barefoot or have wet or damp hands or feet.
- ~ Only dry textiles washed in water.
- ~ Do make sure not to load more than nominal load.
- ~ Remove all items such as lighters and matches from pockets.
- ~ Use fabric softeners or similar products as specified by the manufacturer's packaging.
- ~ Do not place heavy objects or sources of heat or damp on top of the appliance.
- ~ Hold the plug, not the cable, when unplugging the appliance.
- ~ Do not touch the rear wall and the drum during operation; they are hot.



WARNING!

Daily use

- ~ Do not dry following items in the appliance:
 - ~ Items which have been contaminated with inflammable substances such as cooking oil, acetone, alcohol, benzene, petrol, kerosene, spot removers, turpentine, waxes, wax removers or other chemicals. The fumes can cause a fire or explosion. These items must always be washed first by hand in hot water with an extra amount of detergent and then be dried in the open air before drying in the appliance.
 - ~ Items which contain padding or fillings (e.g. pillows, jackets), as the filling can get out with the risk of igniting in the dryer.
 - ~ Items which contain a large proportion of rubber, foam rubber (latex foam) or rubber like materials such as shower caps, waterproof textiles, rubberised articles and items of clothing and pillows with foam rubber filling.
- ~ Do not drink the condensed water.
- ~ Do not use the appliance without the lint filter or condenser filter in place or with damaged filter.
- ~ Notice that the last stage of the drying cycle is a cool down and the dryer will run without heat for a few minutes to ensure that the garments are at a safe temperature to be taken out of the drum. If the cycle is paused during the drying stage, a cool down might take place. Garments may still feel hot to the touch—handle with care.
- ~ **WARNING:** Never stop a tumble dryer before the end of the drying cycle unless all items are quickly removed and spread out so that the heat is dissipated.
- ~ Switch off the appliance after each drying programme to save electricity and for safety.

Maintenance / cleaning

- ~ Make sure children are supervised if they carry out cleaning and maintenance.
- ~ Disconnect the appliance from the electrical supply before undertaking any routine maintenance.



WARNING!

Maintenance / cleaning

- ~ Clean the lint filter and the condenser filter after each programme (refer to CARE AND CLEANING).
- ~ Do not use water spray or steam to clean the appliance.
- ~ Do not use industrial chemicals to clean the appliance.
- ~ Replace a damaged supply cord only by the manufacturer, its service agent or similarly qualified persons in order to avoid a hazard.
- ~ Do not try to repair the appliance by yourself. In case of repair please contact our customer service.

Installation

- ~ Ensure a location which allows opening the door fully. Do not install the tumble dryer behind a lockable door or a door with hinges on the opposite side of the tumble dryer door as this limits the full opening of the tumble dryer door.
- ~ Install the appliance in a well-ventilated, dry place.
- ~ Never install the appliance outdoors in a damp place, or in an area which may be prone to water leaks such as under or near a sink unit. In the event of a water leak cut power supply and allow the machine to dry naturally.
- ~ Install or use the appliance in places where the temperature is above 5 °C. If install the product in a low temperature room, and using the product continuously, there might be some water condensation and drops on floor.
- ~ Do not place the appliance directly on a carpet, or close to a wall or furniture.
- ~ Do not expose the appliance to any frost, heat or direct sunlight or in the near of heat sources(e.g. stoves, heaters).
- ~ Make sure that the electrical information on the rating plate agrees with the power supply. If it does not, contact an electrician.
- ~ Do not use multi-plug adapters and extension cables.
- ~ Make sure not to damage the electric cable and the plug.
- ~ Use a separate earthed socket for the power supply which is easy accessible after installation. The appliance must be earthed.

Intended use

This appliance is intended for drying items which have been washed in a water solution and are marked on the manufacturer’s care label as being suitable for tumble drying.

It is designed exclusively for domestic use inside the house. It is not intended for commercial or industrial use. Changes or modifications to the device are not allowed. Unintended use may cause hazards and loss of all warranty and liability claims.



Notice

The appliance contains the fluorinated greenhouse gas HFC-134a (GWP:1430). This gas is hermetically sealed.



Environmentally responsible use

- ~ **Thorough spin:** Spin the laundry with the maximum spin speed.
- ~ **Maximum load:** Use the maximum filling amount according to the program table, but do not overload the dryer.

MODEL	MAXIMUM CAPACITY (KG)
HDHP80AN1	8
HDHP80ANB1	8

*Capacity refers to the maximum dry weight of items the dryer can dry at any one time

- ~ **Loosen up the laundry:** Shake out the laundry before putting them into the dryer.
- ~ **Avoid excess drying:** An excessive drying should be avoided. Select the right programme and the appropriate dry level.
- ~ **Cleaning of the lint filters:** Clean the lint filters after each cycle.
- ~ **Ventilation:** Make sure the appliance is properly ventilated (refer to INSTALLATION).
- ~ **Condensed water reuse:** The collected condensed water can be used for the steam iron. Before it should be poured through a fine sieve or coffee filter paper. Smallest parts will be retained by the filter.

Notice

Due to technical changes and different models, the illustrations in the following chapters may differ from your model.

3.1 Picture of appliance Front (Fig. 3-1):

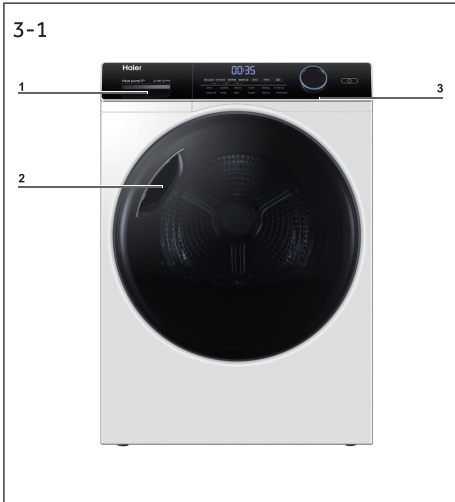

- 1 Water tank
- 2 Door
- 3 Control panel

Rear side (Fig. 3-2):

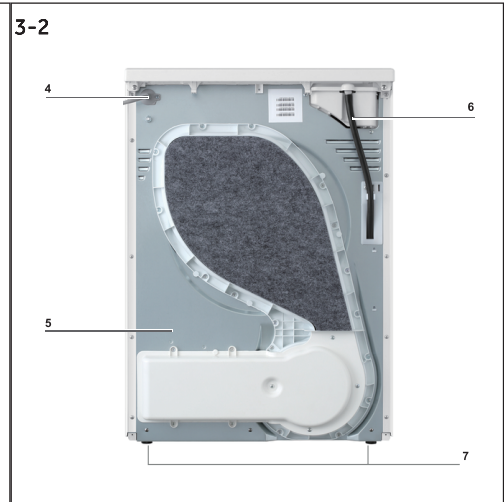

- 4 Power supply cord
- 5 Back plate
- 6 Drainage outlet
- 7 Adjustable feet

3.2 Accessories

Check the accessories and literature in accordance with this list (Fig.3-3):

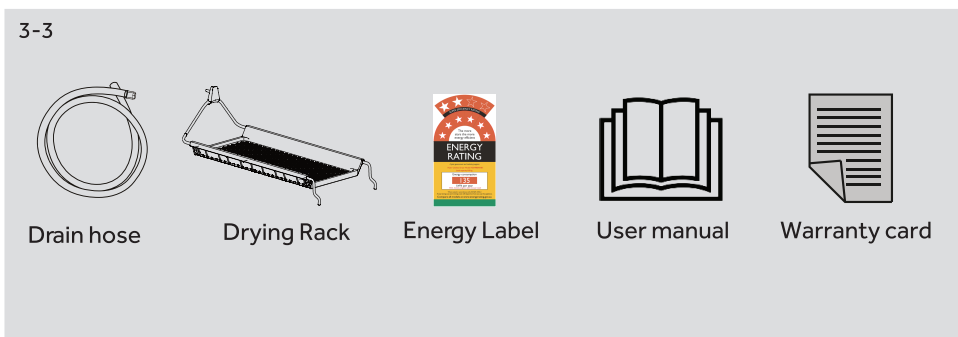

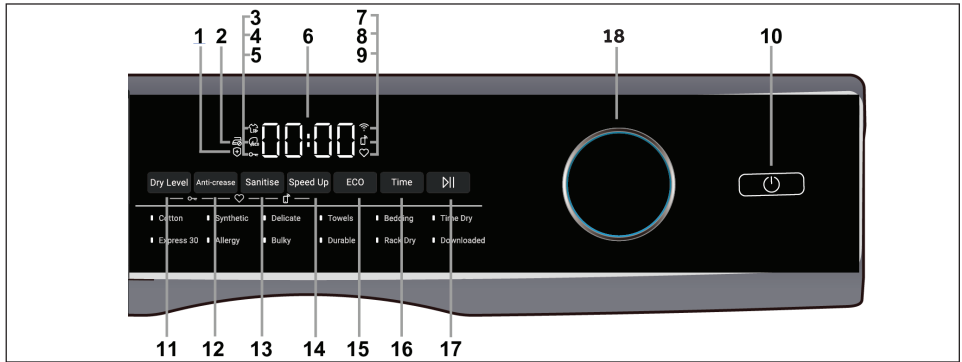

- | | | |
|--------------------------|----------------|-----------------|
| 1 Sanitise indicator | 7 WiFi | 13 Sanitise |
| 2 Anti-crease indicator | 8 Remote mode | 14 Speed Up |
| 3 Speed Up indicator | 9 Memory mode | 15 ECO |
| 4 ECO indicator | 10 Power | 16 Time |
| 5 Keylock | 11 Dry Level | 17 Start/Pause |
| 6 Digital display screen | 12 Anti-crease | 18 Control dial |

4.1 Sanitise indicator

Press the **Sanitise** button to select the sanitise function, then the indicator lights up. When the program enters the sterilization stage, the indicator light flashes.



4.2 Anti-crease indicator

Press the **Anti-crease** button to select the anti-crease function, then the **Anti-crease** indicator lights up.



4.3 Speed Up indicator

Press the **Speed Up** button to select the speed up function, then the Speed Up indicator lights up.



4.4 ECO indicator

Press the **ECO** button to select the **ECO** function, then the **ECO** indicator lights up..



4.5 Keylock

Press and hold **Dry LEVEL** and **Anti-crease** combination keys for three seconds, the **Keylock** icon  lights up on the panel. All buttons on the control panel excepting the **Power** button are disabled. Repeat the operation to release the lock.



4-6



4.6 Digital display screen

Shows the following:

- Dry cycle options and machine settings
- Dry progress
- Notifications if an error is detected or warning is necessary.

4-7



4.7 WiFi

This icon lights up when the dryer network is connected.

4-8



4.8 Remote mode

In standby mode. Press and hold **ECO** and **Speed Up** combination key for three seconds. This icon light is on. **REMOTE MODE** is enabled, certain functions of your dryer can now be accessed via the APP. **REMOTE MODE** will be disabled when turning off the dryer.

4-9



4.9 Memory mode

Press and hold **Anti-crease** and **Time** combination keys for three seconds, The current program and setting function will be set to memory mode, and the next time the program is selected, the memory setting will be automatically called. Repeat the operation to reset the memory mode.

4-10



4.10 Power

Press to turn the **ON/OFF**. Press and hold the **Power** button for five seconds until the power is turned on and the **APP** will be displayed on the screen to turn on the network function.

4-11

Dry Level

4.11 Dry level

Press to select the level of dryness for your load. The corresponding dryness level of L-1, L-2 and L-3 are Damp, Dry and Extra dry.

4.12 Anti-crease

Press to set **Anti-crease** function. When the cycle finishes, your dryer will beep and then turn off automatically. If the Anti-crease option has been selected, the drum will rotate periodically to minimise wrinkling and creasing. This is particularly useful if you cannot remove the items immediately after the cycle ends.

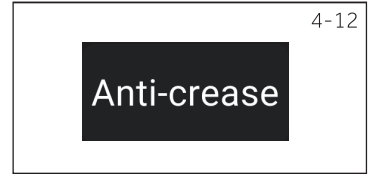

4.13 Sanitise

The dryer has the function of sterilization. This function will extend the drying time. Press the **Sanitise** button to select the function. When the dryer enters the Sanitise phase, the indicator lights up.

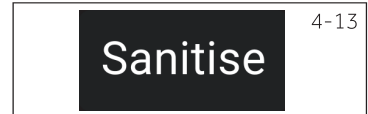

4.14 Speed Up

A special feature designed to offer a shorter cycle whilst providing good dry performance.

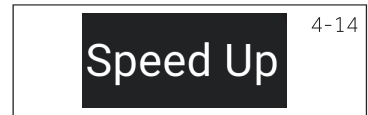

4.15 ECO

Use the **ECO** option to save energy. Selecting **ECO** will reduce the drying temperature slightly.

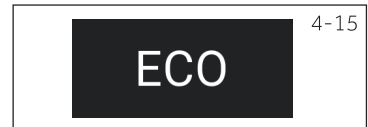

4.16 Time

When a timed cycle is selected, using the **Time** button to adjust the time up or down. For timed cycles, the display will show approximately how many minutes the cycle has remaining. For automatic cycles, the word **AUTO** will appear on the screen.



4.17 Start/Pause

Press to start or pause the selected dry cycle.



4.18 Control dial

Rotate to select your desired drying cycle. White LED illuminates to indicate the selected dry cycle.

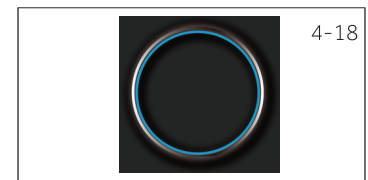

Your appliance may be connected to your home wireless network and operated remotely using the app. Connect your appliance to ensure it stays up to date with the latest software and features.

Getting started:

Ensure both your home Wi-Fi network and Bluetooth on your mobile device are turned on.

You will be given step by step guidance on your mobile device.

It may take up to 10 minutes to connect your appliance.

For further guidance and troubleshooting, please refer to the app.

On your mobile device:

1. Please visit the below webpage to download the SmartHQ App:

Australia <https://www.haier.com.au/smart>

New Zealand <https://www.haier.co.nz/smart>

2. Register and create an account.

Connecting to your home WiFi:

1. Power OFF appliance on the Display, then press and hold the POWER button for 5secs.

The display will indicate 'APP'.

2. On your mobile, launch the SmartHQ App and follow the instructions to 'Add Appliance'.

3. Once the appliance is connected, the Wi-Fi icon  lights up solid.

Enabling remote mode

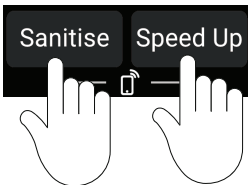

1. Press and hold **Sanitise** and **Speed Up** combination keys for three seconds and the icon  lights up. **Remote Mode** is now enabled. Certain functions of your dryer can now be accessed via the APP.

Disabling remote mode

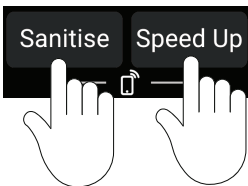

2. Press and hold **Sanitise** and **Speed Up** combination keys for three seconds and the icon  brightness disappears. **Remote Mode** is now disabled.

3. When turning off the dryer, the Remote Mode will be automatically released. When the dryer runs the cycle in Remote Mode via APP, the remote mode indicator  flashes every second. When the user stops the drying cycle which is selected through Remote Mode, the Remote Mode will be disabled.

CYCLE	DEFAULT DRY LEVEL	DESIGNED FOR	MAX. LOAD SIZE (KG)
Cotton	Extra dry	Cotton garments	8
Synthetic	Dry	Synthetic garments	4
Delicate	Dry	Delicate and heat sensitive garments	2
Towels	Extra dry	Towels	6
Allergy	Extra dry	Clothes that need to get rid of mites	2
Bedding	Extra dry	Large bedding items	4
Bulky	Extra dry	Bulky items	2
Durable	Extra dry	Durable garments	8
Time Dry	n/a	A cycle with user selectable drying times	8
Express 30	n/a	Timed cycle for easy drying items	2
Rack Dry	n/a	Using drying rack for items that cannot be tumbled	3
Downloaded	DOWNLOAD PROGRAM VIA OTA		

¹ECO, Cotton program is the recommended energy saving cycle for everyday drying.

Sorting

Sort items into loads of similar items, and loads that will likely take similar times to dry. This prevents the possibility of some items becoming over-dried whilst others are still damp.

Separate coloured items from white/light items where possible, especially when new. Colour run may be an issue, especially if you intend to delay the start of the drying cycle.

Care labels on garments provide valuable information about the fabric type and how the garment should be dried. Always follow the advice on garment labels.

ITEM/DRYING REQUIREMENTS	SUGGESTED CYCLE	COMMENTS
Towels	Towels	Towels produce a lot of lint and are best dried on their own.
Sheets, pillowcases	Bedding	Ensure openings are buttoned/domed before placing in the dryer.
Bulky items – doonas/duvets, sleeping bags and blankets	Bulky	Dry only one bulky item at a time.
Delicates, fine fabrics	Delicate	You can further reduce the dryness level to damp or use drying rack for very delicate items.
Hats and other odd shaped items	Rack Dry	Check on the item regularly throughout the drying cycle. Ensure the rack has been correctly fitted.
Bed linen, tea towels, socks, reusable face masks	Allergy	Ensure the items can safely withstand heat.
Mixed clothes	Cotton or Synthetic	Ensure the items can safely withstand heat.

Before you load

Check pockets for items that could damage your clothes or get caught in the dryer.

- Close zippers, hooks and eyes, and other fastenings (ie fasten the openings of duvet/ doona covers), and remove loose bra wires. These may damage both your dryer and your clothes.
- Items of clothing with screen-printing should be turned inside out to prevent damage to the print.
- Check the lint filter is clean and the water tank is empty (if the dryer is not set up to drain automatically).

Loading

- Garments need to be loaded correctly to minimise creasing and wrinkling, and to ensure the load is dried evenly.
- Allow enough room in the dryer for clothes to tumble freely. Load the dryer in terms of the space the garments take up when dry, rather than when they are wet.
- Shake clothes out and load individually to help items dry evenly and reduce tangling.
- Dry permanent press garments (business shirts) together on the Damp dryness level with Anti-crease option on. This will help reduce wrinkling and the need for ironing. Hang garments as soon as the drying cycle is complete to reduce the need for ironing.

Drying times

- Drying very small loads is inefficient. Try to dry medium to large loads.
- Heavier items (towels, flannelette sheets) will take longer to dry than light items (synthetics and polyester cotton sheets and shirts).
- Drying times can be reduced by spinning the wash load at the highest spin speed suitable for the load type in your washing machine.
- Check bulky items during the cycle to ensure even drying, pause the dryer and reposition the item if necessary.

Lint

Some items are lint givers, while others are lint collectors. Always dry lint givers and collectors separately.

LINT GIVERS	LINT COLLECTORS
Towels	Synthetics, eg polar fleece
Flannelette sheets	Corduroy
	Polyester cottons

Delicate or easily damaged items (eg nylon stockings, fine fabrics, delicate embroidered fabrics) should be dried separately, using the **DELICATE** cycle, or if you do not want them tumbled use the **RACK DRY** cycle. Sleeping bags and other down items should be dried on **BULKY** cycle.

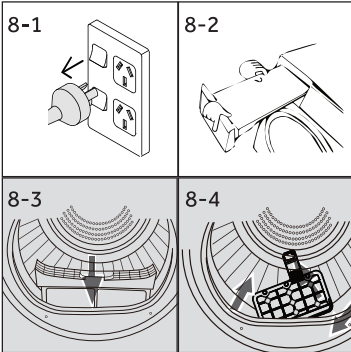

8.1 Preparing the appliance

1. Connect the appliance to a power supply(220V to 240V~/50Hz) .
2. Make sure:
 - the water tank is empty and properly installed. (Fig. 8-2).
 - the lint filter is clean and properly installed. (Fig. 8-3).
 - the condenser filter is clean and properly installed (Fig. 8-4).

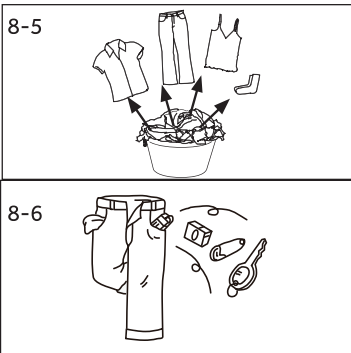

8.2 Preparing the laundry

- Sort clothes according to fabric (cotton,synthetics, wool etc.). Only dry laundry that has been spun.
- Empty pockets of all sharp or flammable objects such as keys and matches.
- Follow the instructions on the laundry label and dry loads that can be dried.



8.3 Activate the dryer

- Press **POWER** to activate your dryer.

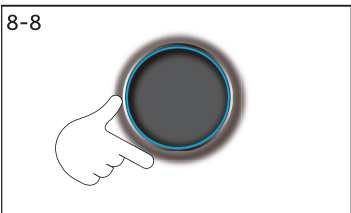

8.4 Set program

1. Select your desired drying cycle by turning the control dial. A LED will illuminate as you turn the dial showing which cycle is selected.
2. Set functions such as **Dry level**, **Sanitise**, **ECO**, **Anti-crease** and **Time**.

8-9

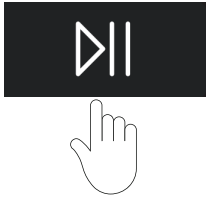

8.5 Start the cycle

1. Press ►|| to start the cycle.

If you wish to change a cycle or select a different option once a drying cycle has started, you should shutdown and restart the dryer.

2. Press ►|| to restart the dryer with the new cycle.

8-10

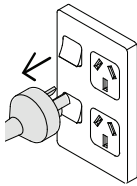

8.6 End of the cycle

Press **POWER** to turn off your dryer and unplug the dry.

8-11

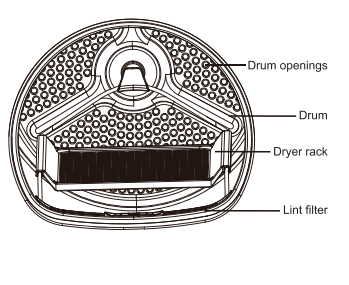

8.7 Drying rack

The dryer rack is designed for use with items which are not recommended for tumble drying such as trainers, sneakers, sweaters or delicate lingerie.

1. Open the dryer door.
2. Check that the drum is empty.
3. Put the dryer rack into the drum.
4. Make sure the catches are inserted in the hole of the lint filter and locked in the hole of rear drum.

When the cycle finishes, your dryer will beep and then turn off automatically. If the **Anti-crease** option has been selected, the dryer will rotate the drum periodically to help minimise wrinkling and creasing of your load.

If you wish to stop the dryer before the cycle has finished you **MUST** remove the clothes **IMMEDIATELY** and spread them out to cool. **DO NOT** leave the clothes in the dryer or bunched up in a clothes basket. Take extreme care as the drum and the load items may be extremely hot.

9-1

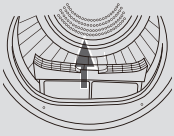

9.1 Lint filter cleaning

Clean the lint filter after each dry cycle.

1. Remove the lint filter from the drum (Fig. 9-1).

9-2

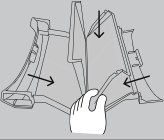

2. Open up the lint filter (Fig. 9-2).

9-3

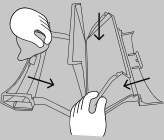

3. Clean the lint filter form any lint residuals (Fig.9-3).

9-4

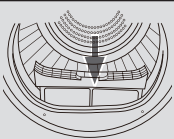

4. Reinstall the cleaned lint filter in the tumble dryer (Fig. 9-4).

9-5

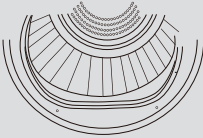

9.2 Condenser filter cleaning

Clean the lint filter after each dry cycle.

1. Open the door.

9-6

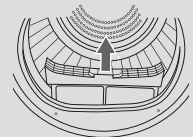

2. Pull out the lint filter from its housing (Fig. 9-5).

9-7

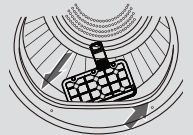

3. Pull out the condenser filter from the air duct (Fig. 9-6)

9-8

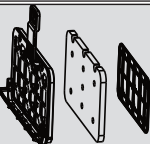

4. Remove the sponge and clean the filter screen form any residuals (Fig. 9-7).

5. Reinstall the sponge to the condenser filter (Fig. 9-8)

9.3 Emptying the water tank

Empty the water tank after each drying cycle.

1. Pull out the water tank from its housing (Fig. 9-9).
2. Empty the water tank (Fig. 9-10).
3. Reinstall the water tank to the dryer (Fig. 9-11)

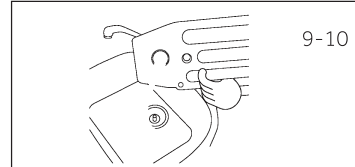

9.4 Clean the sensors

There are sensors in your dryer that detect whether the laundry is dry or not. These sensors need to be cleaned periodically (we recommend approximately four times a year).

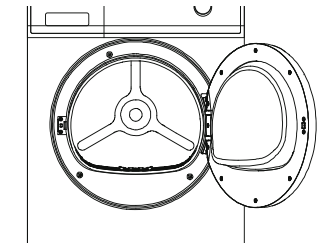

1. Open the door of your dryer. Allow the dryer to cool if drying has been carried out.

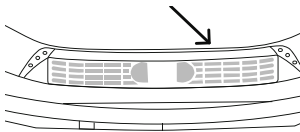

2. Locate the metal sensors just behind the lint filter.

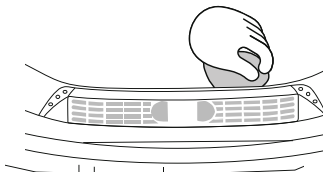

3. Wipe the sensors with a soft cloth, dampened with vinegar and dry with a clean dry soft cloth.

9.5 Clean the dryer

Wipe the outside of the tumble dryer and the control panel with a damp cloth. Do not use any organic solvent or corrosive agent to avoid damage to the device.

9.6 Clean the Drum

After some operation time, fabric care agents or calcium contained in the water can form an almost invisible film on the inside of the drum. Use a damp cloth and some detergent to remove it. Do not use any organic solvent or corrosive agent to avoid damage to the device.

User warnings

Your dryer is capable of diagnosing a number of its own problems. It will sound a continuous series of beeps and display a user prompt when it has a problem that you can correct yourself. To stop the beeps sounding, touch any button on the control panel. Do not try to continue your drying cycle once you stop the noise. You must address the problem the dryer is alerting you to.

Check the below table before you call for service.

NOTIFICATION	WHAT TO DO
KEYLOCK ON	Touch and hold the Dry level and Sanitise combination button for three seconds to deactivate the Keylock.
CLEAN FILTERS AND EVAPORATOR GRID	Clean lint and condenser filters and carefully vacuum the evaporator grid. Check the lint filter or condenser filter are not damaged. Check there is nothing else trapped in the filters or evaporator grid, which may be blocking the air flow. Check the filters are correctly in place in your dryer.
WATER TANK	Check if the water tank is full. Empty the water tank. If using the drain hose, check whether the water tank or drain hose is blocked. Check the drain hose is still attached at the back of the machine, and is not kinked or squashed.
DOOR OPEN	Close the door fully and touch ►II. Try opening and closing the door again. Reposition the load, make sure the load is correctly in the drum and that protruding items are not preventing the door from closing.
THE LAUNDRY ENVIRONMENT IS TOO COLD FOR THE DRYER TO FUNCTION	The room temperature is too low for the heat pump system to work effectively. Ensure that the room temperature is above five degrees to avoid loss of efficiency.
MAXIMUM CYCLE TIME HAS BEEN REACHED	There are a number of reasons the maximum cycle time has been reached, refer to 'Troubleshooting', 'Dryer is taking too long.' for possible causes and solutions.

Once you have addressed the issue the user prompt was alerting you to, try using your dryer as per usual. If the issue persists, call your Fisher & Paykel trained and supported service technician.

When a continuous series of beeps sound, all the lights turn off on the control panel and a string of codes appears on the display, a fault has occurred. Please refer to the following instructions.

Code	Cause	Solution
<i>F2</i>	Drain pump failure	Contact the customer service.
<i>F32</i> <i>F33</i> <i>F34</i>	The condenser thermal sensor is open-circuited or short-circuited.	Contact the customer service.
<i>F4</i>	Temperature of the laundry in the drum does not change.	Contact the customer service.
<i>Fc2</i>	Communication failure between PCB and display.	Contact the customer service.
<i>Lint</i> <i>cln</i>	The lint filter is blocked and needs to be emptied.	Empty the lint filter and then replace it and check the lint filter is not damaged. Check there is nothing else stuck in the lint filter holder which may be blocking the air flow.
<i>H20</i> <i>FULL</i>	The water tank is full and needs to be emptied.	Check and empty the water tank, if using drain hose, check whether the water tank or drain hose is blocked.
<i>Fh</i>	Network configuration failure	Turn off the dryer.

PROBLEM	POSSIBLE CAUSES	WHAT TO DO
Small amount of water in the drum at end of cycle	Water tank needs to be emptied.	Refer to 'Emptying the water tank'.
	Environmental conditions may be affecting dryer operation.	If conditions are particularly hot, humid or cold, it is possible vaporised water may re-condense in the drum or on the inside of the door
Noises	Dryer is overloaded.	Remove some items from the dryer.
	Dryer has a fault.	Continuous beeping or a musical series of beeps with a message displayed on the display. Refer to 'Fault codes'.
	Dryer has not been levelled properly.	Adjust the adjustable foot under the dryer. Refer to 'Levelling the dryer'.
	Dryer makes unfamiliar noises.	At the start of the cycle the dryer may make some unfamiliar noises when the compressor turns on. This is normal.
Vibration	Dryer is not installed on a stable surface.	Ensure the dryer is installed on a flat, stable surface.
	Dryer is not level.	Ensure the dryer is correctly levelled.
	Dryer is overloaded.	Remove some items from the dryer.
Creasing	Cycle selection not appropriate for the load.	Choose appropriate cycle. Refer to 'Dry Cycles'
	Dryer is overloaded.	Remove some items from the dryer.
	Dry Level selected too high for load type.	Try selecting a lower Dry Level.
Dye transfer	White/light and coloured items not separated before drying.	Remember to separate white/light and coloured items before placing them in the dryer.
	Wet items left sitting in the dryer for long periods of time before drying.	Refer to 'Sorting' for tips to prevent dye transfer.

PROBLEM	POSSIBLE CAUSES	WHAT TO DO
Linting	Lint filter not cleaned or replaced.	Ensure the lint filter is cleaned after every cycle and replaced correctly. Refer to 'Cleaning the filters'.
	Loads not sorted correctly.	Dry lint-giving items separately from lint receivers. Also, dry similar colours together, eg light coloured items with light coloured items, dark items with dark items. Refer to 'Sorting'.
	Clothes over dried.	Over drying clothes in the dryer can cause them to attract lint. Use an auto sensing cycle or ensure you check your load if using the time dry cycles to avoid over drying.
Fabric damage	Instructions on care label not followed.	Follow the instructions on the care label of the items.
	DRYNESS LEVEL selected not appropriate for the fabric type.	Ensure the DRYNESS LEVEL selected is appropriate for the fabric type. Refer to the items care label. Refer to 'Drying rack'.
	Metal parts on the items or in the load.	Fasten zips and other clasps before placing items in the dryer.
	Items not separated or dried on an appropriate cycle for the fabric type.	Dry similar items together. Ensure an appropriate cycle is selected. Refer to 'Drying rack'.
	Items fell off the rack when using RACK DRY .	Ensure the rack is installed correctly (refer to 'Sorting', 'Drying rack') and only one or two garments are placed on the rack at a time.
	Used a TIME DRY cycle and did not monitor the dryness of clothes during the cycle.	Ensure that clothes are checked for dryness during the cycle when using the timed programmes to avoid over drying.

PROBLEM	POSSIBLE CAUSES	WHAT TO DO
<p>Tangling</p>	<p>Loads not separated during loading.</p>	<p>Try separating out larger items from smaller items.</p>
	<p>Items loaded into the dryer incorrectly.</p>	<p>Load items individually into the dryer. Do not place folded items in the dryer.</p>
	<p>Load size too large.</p>	<p>Try drying smaller load sizes. Some cycles have a lower maximum load size. Refer to 'Drying rack'.</p>
	<p>Delicate items not dried on RACK DRY.</p>	<p>Dry pantyhose, bras, stockings and any other delicate items prone to tangling on the RACK DRY cycle.</p>
	<p>Sheets and duvet/doona covers due to their size, are prone to tangling.</p>	<p>Dry sheets and duvet/doona covers separately from other laundry, apart from towels. Ensure duvet/doona covers are buttoned or fastened closed before drying. Try adding a knotted towel to sheets loads if you are experiencing a lot of tangling.</p>

Freestanding & Stacking

Your dryer can be installed one of two ways, either freestanding, or stacked on top of a Haier front loading washer.

1. The dryer stands on the floor and can easily be moved into position.
2. Your dryer has been designed to be able to be stacked on top of a Haier front loading washer.
A stacking kit **MUST BE USED** between the products and fitted correctly to the washing machine and dryer, as per the stacking kit instructions.

Reversing the door swing

These instructions are for changing the hinges from the right side to the left side. If you ever want to switch them back to the right side, follow these same instructions and reverse all references to the left and right.

1. Remove the door assembly

Open the door. Remove the two screws holding the hinge/door assembly to the dryer. Carefully set the hinge/door assembly aside (Fig. 13-1).

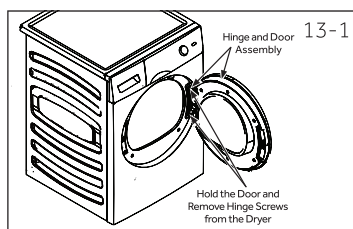

2. Remove, rotate and replace the inner door

Remove the eight stickers and screws securing the inner door to the outer door. Remove the inner door, rotate it 180° and reinstall it into the outer door using the same eight screws and stickers (Fig. 13-2).

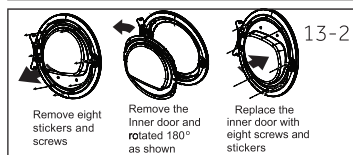

3. Remove, rotate and replace the door lock & strike plate

Remove the two screws holding the strike plate, and then remove one screw of the door lock, push down and take out the lock rotated 180° and install it on the opposite side. the same eight screws and stickers (Fig. 13-3).

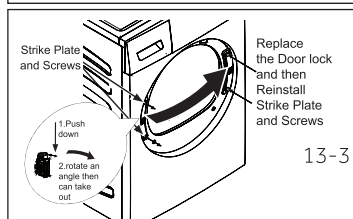

4. Rotate and replace the hinge/door assembly

Rotate the hinge/door assembly and secure with same two screws on the hinge/door assembly to the dryer. (Fig. 13-4).

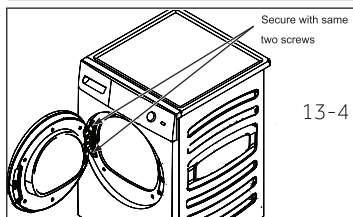

Levelling the dryer

It is **IMPORTANT** to level the dryer to ensure the machine runs efficiently with minimal noise. The dryer should be levelled in as close to its final position as possible so it stands balanced evenly on all four feet. Ensure the dryer does not rock in any direction.

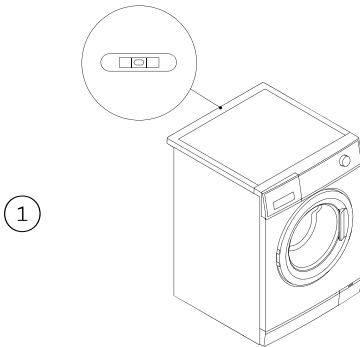

Level the dryer side to side:

- Place the level at the centre back of the dryer.
- Adjust the rear feet until the dryer is level side to side.
- Never unscrew the feet completely from their housings.

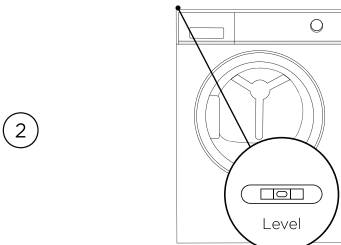

Level the dryer front to back:

- Place the level on the left side.
- Adjust the front left foot (wind down).
- Repeat the above for the right foot.
- There should be equal weight on both front feet.

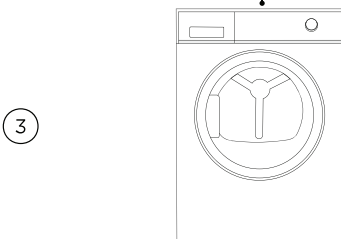

Re-check the dryer is level:

- Place the level at the centre front of the dryer
- Ensure dryer does not rock in any direction.
- If dryer is not level repeat the above steps.

After levelling, the corners of the dryer cabinet should be clear of the floor and the dryer must not rock in any direction.

Draining

The dryer is equipped with a condenser unit which accumulates water during the drying cycle. This water is collected in the removable water tank located at the top left of the dryer. The accumulated water must be emptied after each drying cycle or you can setup your dryer to drain automatically using the drain hose provided.

We recommend the dryer is set up to drain automatically where possible especially when drying full loads, this will avoid having to empty the water tank during a drying cycle.

Connecting the drain hose

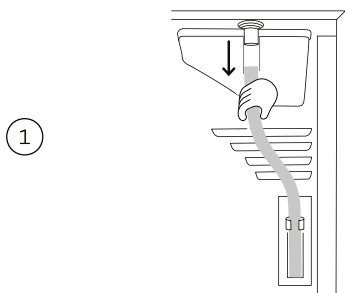

Remove the black hose from the connection at the back of the dryer.

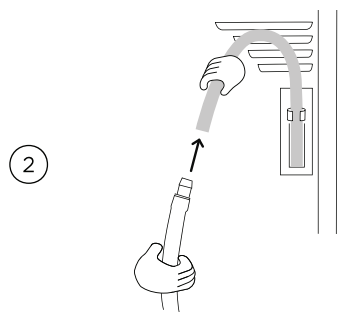

Uncoil the drain hose (included with your dryer) and connect it to the black hose.

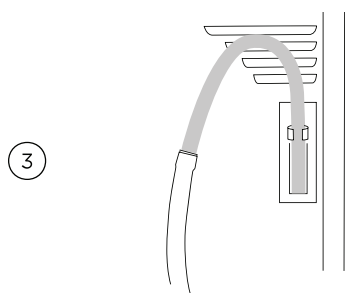

Place the other end of the drain hose into a tub or standpipe.

For New Zealand and Australia only. You automatically receive a 2 year Manufacturer's Warranty with the purchase of this heat pump clothes dryer covering parts and labour for servicing within the country of purchase.

Haier undertakes to:

Repair or, at its option, replace without cost to the owner either for material or labour any part of the product, the serial number of which appears on the product, which is found to be defective within TWO YEARS of the date of purchase.

Note: This Manufacturer's Warranty is an extra benefit and does not affect your legal rights.

This Manufacturer's Warranty DOES NOT cover

- Ⓐ Service calls which are not related to any defect in the product. The cost of a service call will be charged if the problem is not found to be a product fault.
For example:
 - ① Correcting the installation of the product.
 - ② Instructing you how to use the product.
 - ③ Replacing house fuses or correcting house wiring or plumbing.
 - ④ Correcting fault(s) caused by the user.
 - ⑤ Noise or vibration that is considered normal, eg drain/fan sounds, machine noises or user warning beeps.
 - ⑥ Correcting damage caused by pests, eg rats, cockroaches, etc.
 - ⑦ Poor drying performance due to incorrect installation and maintenance eg blocked lint filter, blocked condenser or full water tank.
 - ⑧ Poor drying performance due to incorrect loading, eg overloading or underloading.
 - ⑨ Damage from articles in the drum, eg bra wires, pens, crayons, dye transfer or flammable material.
- Ⓑ Defects caused by factors other than:
 - ① Normal domestic use; or
 - ② Use in accordance with the product's User guide.
- Ⓒ Defects to the product caused by accident, neglect, misuse or 'act of God'.
- Ⓓ The cost of repairs carried out other than by a Fisher & Paykel trained and supported service technician or the cost of correcting such repairs.
- Ⓔ Normal recommended maintenance as set out in the product's User guide.
- Ⓕ Repairs when the appliance has been dismantled, repaired or serviced by other than a Haier trained and supported service technician or the selling dealer.
- Ⓖ Pick-up and delivery.
- Ⓗ Transportation or travelling costs involved in the repair when the product is installed outside the Haier trained and supported service technician's normal service area.

Nothing in this Manufacturer's Warranty is intended to, or does, limit any rights you may have under law to recover the costs of inspecting or returning the goods to us.

This product has been designed for use in a normal domestic (residential) environment. This product is not designed for commercial use (whatsoever). Any commercial use by a customer will affect this product's Manufacturer's Warranty.

Service under this Manufacturer's Warranty must be provided by a Haier trained

and supported service technician (refer to the 'Before you call for service'). Such service shall be provided during normal business hours. This Manufacturer's Warranty certificate should be shown when making any claim.

For Australian Customers

This Manufacturer's Warranty is an extra benefit and does not affect your legal rights. Our goods come with guarantees that cannot be excluded under the Australian Consumer Law. You are entitled to a replacement or refund for a major failure and for compensation for any other reasonably foreseeable loss or damage. You are also entitled to have the goods repaired or replaced if the goods fail to be of acceptable quality and the failure does not amount to a major failure.

Please keep this user guide in a safe place.

We recommend our Haier Customer Service and the use of original spare parts.
If you have a problem with your appliance, please first check section TROUBLESHOOTING.

If you cannot find a solution there, please contact

- ~ your local dealer or
- ~ the Service & Support area at www.haier.com where you can find telephone numbers and FAQs and where you can activate the service claim.

To contact our Service, ensure that you have the following data available.
The information can be found on the rating plate.

Model _____ Serial No. _____

Also check the Warranty Card supplied with the product in case of warranty.

For general business requires please find below our addresses in New Zealand and Australia.

For more information, please refer to WWW.HAIER.COM.

HDHP80AN1/HDHP80ANB1

Haier



0180501350